



Synergy Global Technology Inc

www.RackmountMart.com

Toll Free: 1-888-865-6888

Tel: 510-226-8368 Fax: 510-226-8968

Email: sales@RackmountMart.com

LCD1U17-43

**Single Rail 17.3" Full HD LCD Console
User Manual**

Packing List

The complete LCD1U17-43 package consist of:

- One 1U 19" rack mount console
- Two rails with front and rear bracket
- Two long brackets. (Needed for rack depth 800 ~ 1000mm)
- One 1.8M signal cable
- One power cord
- One user manual CD
- One quick installation guide
- Key x 2
- USB cable x 2
- DVI cable x 1
- Six flat screws. (for rail mount to console body)
- Six screws. (for replace long bracket)

Check to make sure that the unit was not damaged in shipping. If you encounter a problem, contact your dealer.

Please read this manual thoroughly, and follow the installation and operation procedures carefully to prevent any damage to the product, and/or any of the devices that connect to it.

Safety Instructions

1. Please read these safety instructions carefully.
2. Please keep this User's Manual for later reference.
3. Please disconnect this equipment from AC outlet before cleaning. Don't use liquid or sprayed detergent for cleaning. Use moisture sheet or clothe for cleaning.
4. For pluggable equipment, the socked-outlet shall be installed near the equipment and shall be easily accessible.
5. Please keep this equipment from humidity.
6. Lay this equipment on a reliable surface when install. A drop or fall could cause injury.
7. Do not leave this equipment in an environment unconditioned, storage temperature above 60⁰ C, it may damage the equipment.
8. The opening on the enclosure is for air convection hence the equipment from overheating. DO NOT COVER THE OPENING.
9. Make sure the voltage of the power source connect the equipment to the power outlet.
10. Please keep the power cord such a way that people can not step on it. Do not place anything over power cord. The power cord must rate for the voltage and current marked on the product's electrical ratings label. The voltage and current rating of the cord should be greater than the voltage and the current rating marked on the product.
11. All cautions and warning on the equipment should be noted.
12. If the equipment is not in use for long time, disconnect the equipment from mains to avoid being damaged by transient over-voltage.
13. Never pour any liquid into ventilation openings; this could cause fire or electrical shock.
14. Never open the equipment. For safety reason, qualified service personnel should only open the equipment.
15. If one of the following situations arises, get the equipment checked by service personnel.
 - The Power Cord or plug is damaged.
 - Liquid has penetrated into the equipment.
 - The equipment has been exposed to moisture.
 - The equipment has not worked well or you can not get it work according to User's Manual.
 - The equipment has dropped and damaged.
 - If the equipment has obvious signs or breakage.

Index of Contents

Packing List.....	I
Safety Instructions.....	II
Index of Contents	IV
1. General Information.....	5
1.1 Overview.....	5
1.2 Product Specification	2
1.2.1 LCD1U17-43 Specification.....	2
2. Panel Controls and OSD Function.....	4
2.1 Auto Tune	4
2.2 Input Source	4
2.3 Brightness.....	5
2.4 Contrast	5
2.5 Color	6
2.6 Position	6
2.7 Language.....	7
2.8 Recall.....	8
2.9 Exit.....	8
2.10 Power Indicator.....	8
3. Installation	9
3.1 Install LCD1U17-43 into Cabinet.....	9
3.1.1 Notes	9
3.1.2 Hardware Kits Contents	9
3.1.3 Installation Steps.....	10
3.1.4 Replace Longer Bracket Steps (For rack depth 800~1000mm)	12
3.1.5 Unload Steps	12
3.3 Installing the Video Card and Video Driver	14
3.3.1 Configuring the Display Settings.....	14
3.3.2 LCD1U17-43 I/O Diagram.....	15
3.4 Turning on the Console.....	16
3.5 Testing the Console.....	16

1. General Information

1.1 Overview

The KVM console is an ideal solution for network administration with multiple servers / platforms. Their 17.3-inch large size TFT LCD color display and ultra-low-profile compact industrial keyboard / touchpad provide the user-friendliest and most reliable environment for network administrators. All these functions are integrated in a 19-inch 1U space with rugged construction design to achieve ultra space saving and high reliability for high quality industrial network applications. The KVM console provide superior picture quality and state-of-the-art features mounted in an industrial grade, rack mount console. The console forms a rugged enclosure that protects the panel from industrial hazards and permits easy access to panel controls.

The KVM console panels provide flicker-free color images at optimal resolutions. The panels' 0.1989 x 0.1989mm pixel pitch - 17.3 inch ensures crisp images with clear definition, even at high resolutions. The KVM console panels are intelligent, microprocessor-based, and have an ergonomically designed display. The KVM console panels employ the latest in active matrix thin film transistor (TFT) technology, providing crisp screen images and wide viewing angles. Unlike CRT panels, LCD panels are inherently immune to the magnetic fields commonly found on the plant floor or communications centers. LCDs are also typically brighter than conventional CRT technology, making them ideal for the high ambient lighting conditions found in many of today's factory environments. On-screen menus allow for display adjustments. In addition, the panels' Plug-n-Play+ features support Dos, Unix, Linux, OSX, Windows, while a universal power supply ensures global applicability.

The KVM console panels are compatible with most analog RGB (red, green, blue) display standards, including PS/2, optional for Sun Micro System, Apple Macintosh Centris, Quadra, and Macintosh II family signals. The LCD panel is capable of displaying crisp and vibrant color graphics with VGA, SXGA, XGA (non-interlaced), SXGA, UXGA, Full HD and most Macintosh compatible color video cards.

1.2 Product Specification

1.2.1 LCD1U17-43 Specification

Model name	LCD1U17-43	
Number of ports	1	
Dimension	480.8 x 482.0 x 43.8 mm / 18.9 x 19.0 x 1.7 inches	
Net Weight	12.0 Kg / 26.5 lbs	
Display Size	17.3 inches	
Panel Type	Active Matrix TFT LCD	
Resolution Capabilities	Maximum Resolution up to 1920 x 1080 (Full HD)	
Pixel Pitch	Supports 0.1989 mm x 0.1989 mm	
Viewing Angle (CR>10)	Right-Left View 140°(Typ) Up-Down View 120°(Typ)	
Contrast Ratio	650:1	
Brightness	White 300 cd/m ² (Center 1 point Typ)	
Back Light	Dual Lamps for Back Light	
Supported Colors	16.7M Colors (6-bit with FRC)	
Response Time	Rising Time 2 ms, Decay Time 6 ms	
Operating System	Dos, Unix, Linux, OSX, Windows (XP, 7, 8, Server 2012 R2)	
Connectors	USB Hub Port (option)	2 x USB 2.0 Type-A Female
	PC Port / Daisy Chain Connectors	1 x DVI 1 x VGA HDDB 15-pin 2 x PS/2 Mini Din 6-pin 1 x USB 2.0 (Keyboard/Mouse) 1 x USB 2.0 Hub (option)
	Power Connector	1 x AC Inlet
Signal Cable	VGA, DVI	
Keyboard Mouse	106 key PS/2 keyboard with touch pad	
Sync	45 ~ 80 KHz	
Power Source	100 ~ 240 VAC input	
Power Consumption	8.3 W for Panel	
Temperature	Operate 0 ~ 50°C / 32 ~ 122°F Storage -20 ~ 60°C / -4 ~ 140°F	
Humidity	10% ~ 90% RH	
Chassis Construction	Heavy duty steel materials	
Keyboard Language	US, UK, German, French, Spanish, Italian, Portuguese, Dutch, Swiss, Belgium, Swedish, Hebrew, Norwegian, Danish, Japanese, Mandarin, Russian, Arabic	

Table 1-1. LCD1U17-43 Specification

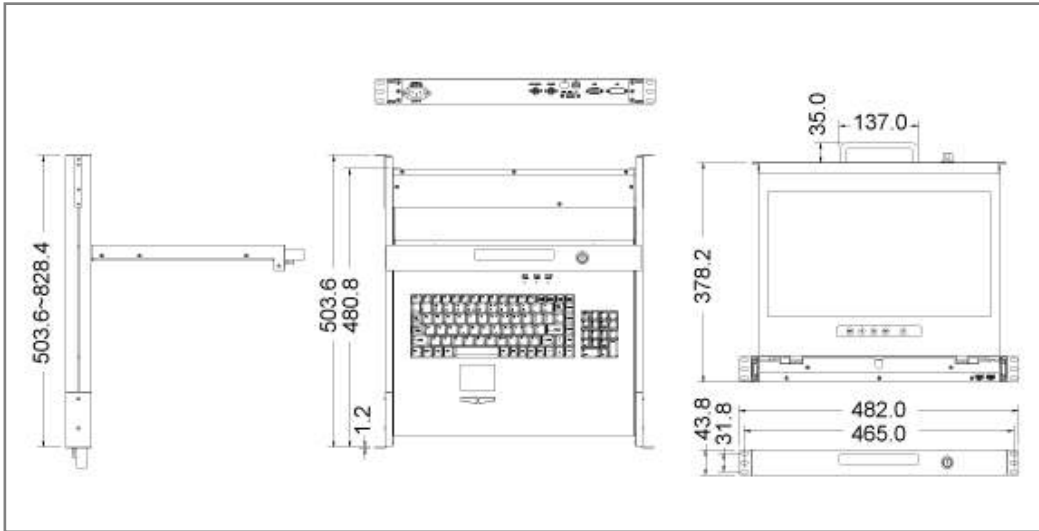

Figure 1-1. LCD1U17-43 Dimension

2. Panel Controls and OSD Function



Controls	Description
	Soft power on/off button. Adjacent LED is lit when on.
Auto	Auto-synchronize and scale down display to any valid factory preset timings.
	Press to scroll the function you want to adjust.
	Press to scroll the function you want to adjust.
Menu	To access the main menu. This button also acts as the “Enter” button.

Table 2-1. Panel Controls

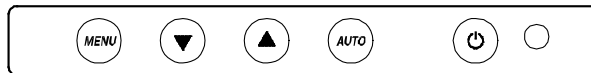

Figure 2-1. LCD1U17-43 OSD Control Bar

2.1 Auto Tune

Press the “auto tune” button. The panel will adjust the display size automatically and also tune the panel to its best condition.

2.2 Input Source

1. Press the “menu” button.
2. Use the “Down” and “Up” button to scroll.

Auto tune.

Input Source

Brightness

Contrast

Color

Position

Language

Recall

Exit

3. Press the “menu” button to enter, and you will see:
VGA / DVI
4. Use the “Down” and “Up” button to select the input source of signal.
5. Press the “menu” button to enter

2.3 Brightness

1. Press the “menu” button.
2. Use the “Down” and “Up” button to scroll.
Auto tune.
Input Source
Brightness
Contrast
Color
Position
Language
Recall
Exit
3. Press the “menu” button to enter.
4. Use the “Down” and “Up” button to adjust the brightness of the display.
5. Press the “menu” button to enter.

2.4 Contrast

1. Press the “menu” button.
2. Use the “Down” and “Up” button to scroll.
Auto tune.
Input Source
Brightness
Contrast
Color
Position
Language
Recall
Exit
3. Press the “menu” button to enter.

4. Use the “Down” and “Up” button to adjust the contrast of the display.
5. Press the “menu” button to enter.

2.5 Color

1. Press the “menu” button.
2. Use the “Down” and “Up” button to scroll.

Auto tune.
 Input Source
 Brightness
 Contrast
Color
 Position
 Language
 Recall
 Exit

3. Press the “menu” button to enter. And you will see:

Icon	Description
9300°K	To set CIE coordinates at 9300°K color
7500°K	To set CIE coordinates at 7500°K color
6500°K	To set CIE coordinates at 6500°K color
User	To set user defined CIE
Auto color	To auto adjust color
Return	To exit and return to the previous page

Table 2-2. Icon Description

4. Use the “Down” and “Up” button to adjust the color of the display.
5. Press “menu” to enter.

2.6 Position

1. Press the “menu” button.
2. Use the “Down” and “Up” button to scroll.

Auto tune.
 Input Source

Brightness
 Contrast
 Color
Position
 Language
 Recall
 Exit

3. Press the “menu” button to enter. And you will see:

Icon	Description
Image Pos	To adjust the position of the image.
OSD Pos	To adjust the position of the OSD.
Return	To exit and return to the previous page

Table 2-3. Icon Description

4. Use the “Down” and “Up” button to scroll.
5. Press the “menu” button to enter.

2.7 Language

1. Press the “menu” button.
2. Use the “Down” and “Up” button to scroll.
 - Auto tune.
 - Input Source
 - Brightness
 - Contrast
 - Color
 - Position
 - Language**
 - Recall
 - Exit
3. Press the “menu” button to enter. And you will see:

English
 German
 French
 Italian

Spanish

4. Use the “Down” and “Up” button to scroll.
5. Press the “menu” button to enter.

2.8 Recall

1. Press the “menu” button.
2. Use the “Down” and “Up” button to scroll.

Auto tune.

Input Source

Brightness

Contrast

Color

Position

Language

Recall

Exit

3. Press the “menu” button to enter, and you will see:

Yes/ No

4. Select “Yes” button then ‘Menu’ button to recall the factory setting.
Select “No “ to return to the previous page.

2.9 Exit

Press the “exit” button to quit OSD menu.

2.10 Power Indicator

- ◆ GREEN ON
- ◆ RED STANDBY
- ◆ RED SUSPEND
- ◆ RED OFF



OSD – On Screen Display

3. Installation

3.1 Install LCD1U17-43 into Cabinet

3.1.1 Notes

1. Please check all peripherals according the list before installation. To make sure that the whole unit was not damaged and lost during shipping process. If you encounter any problem, please contact your dealer.
2. Before installation, make sure all peripherals and computer have been turned off.

3.

Model name	The cabinet depth range
LCD1U17-43	504~1000mm

Contact your dealer for deeper cabinet.

4. Reliable grounding of rack-mounted equipment should be maintained. Particular attention should be given to supply connections other than direct connections to the branch circuit.

3.1.2 Hardware Kits Contents

1. Rail with front and rear bracket x 2. (Please identify the brackets. Right and left sides are different. For rack depth 504 ~ 800 mm)

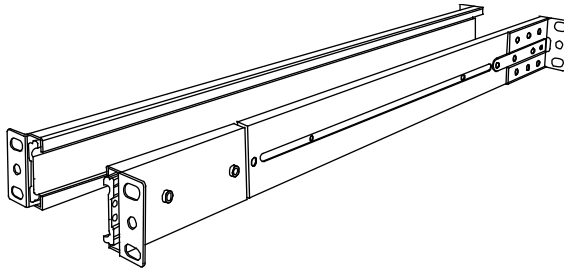

2. Long bracket x 2. (Needed for rack depth 800 ~ 1000mm)

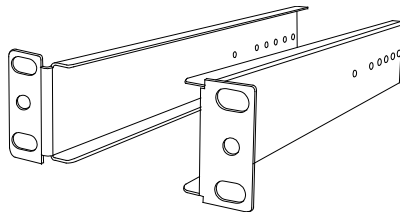

3. Flat screw x 6 (for rail mount to console body)



4. Screw x 6



5. Key x 2

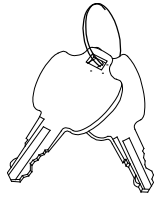

3.1.3 Installation Steps

1. Loose (Not release) four rear screws then adjust rear bracket to fit your cabinet.

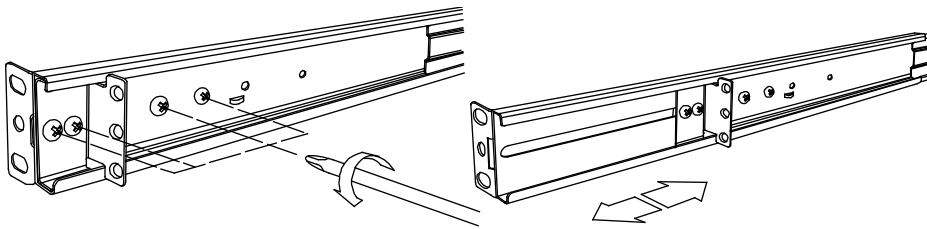

2. Install front and rear bracket on cabinet.

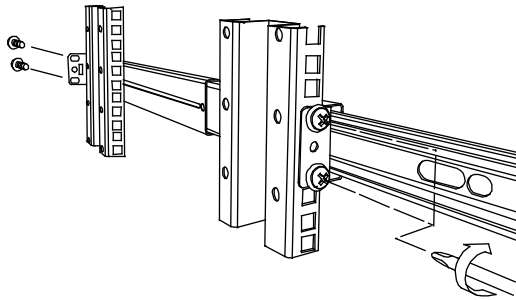

3. Tight-up four rear screws.

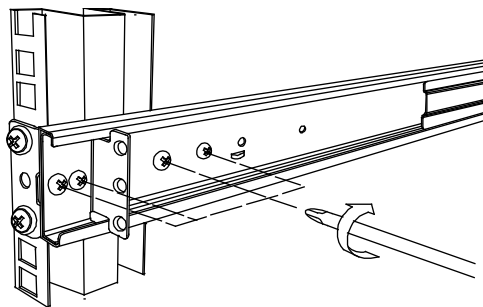

1. Repeat step 1~3 for the other side.

5. Push console into left and right rails. (Be careful when take out console.)

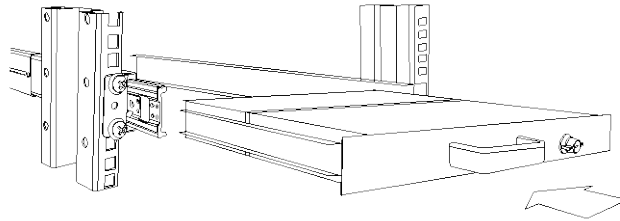

6. Unlock and pull rail-lock switch (left and right at the same time) then push console to the end.



lock



unlock

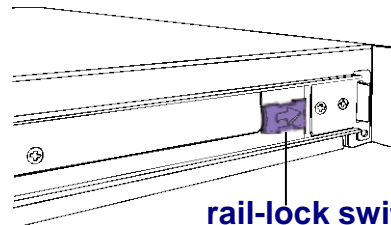
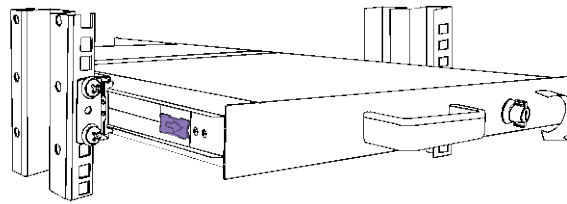

rail-lock switch

7. Install three screws in rear of the console. (Both sides)

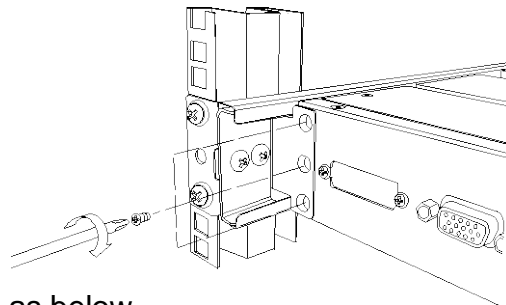

8. Finish installation as below.

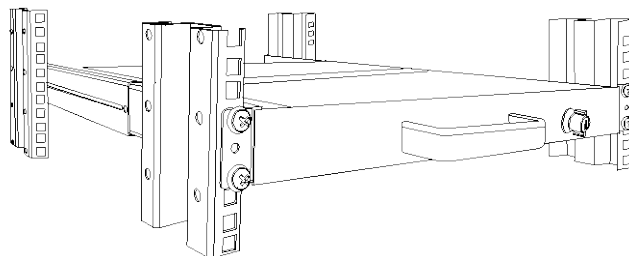

3.1.4 Replace Longer Bracket Steps (For rack depth 800~1000mm)

1. Release six screws.

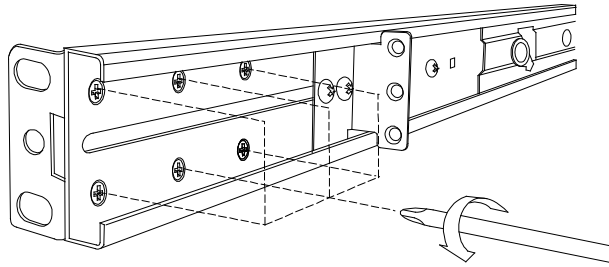

2. Take rear bracket out.

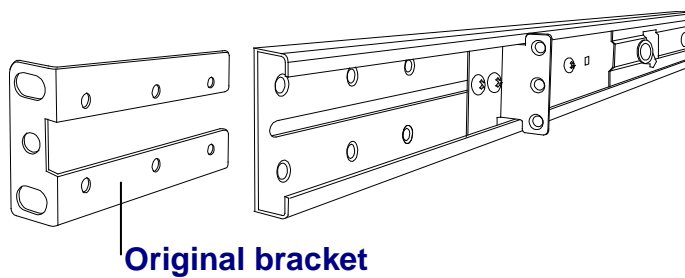

- 2 Input rear long bracket to rear of the rail then adjust rear bracket to fit your cabinet. Tight-up 2~3 screws upon the length you need. One is forbidden.

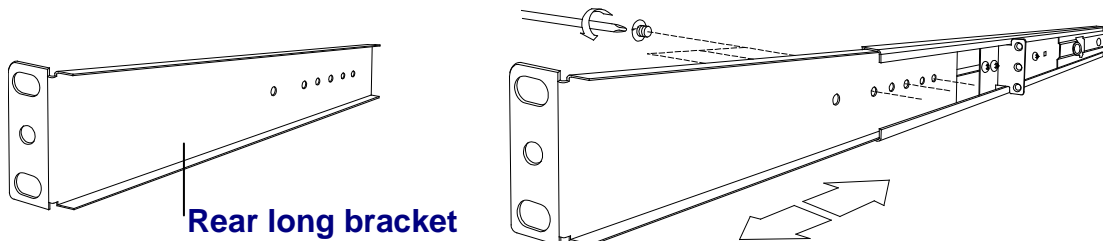

4. Repeat step 1~3 for the other side.
5. Repeat 3.1.3 step to install console.

3.1.5 Unload Steps

1. Make sure the console is lock.
2. Release three screws in rear of the console. (Both sides)

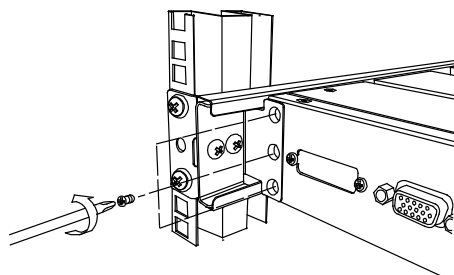

3. Unlock.

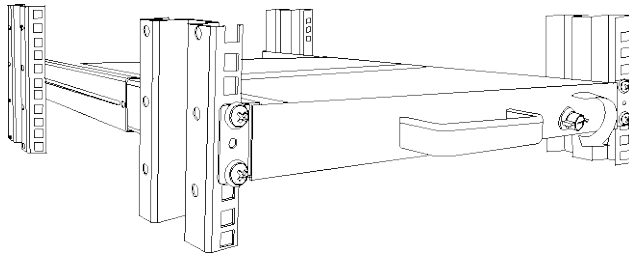

4. Pull console out until console lock.

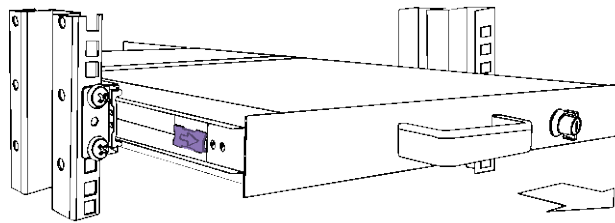

5. Pull rail-release switch and pull console out.(Both sides. Be careful when pull out console.)

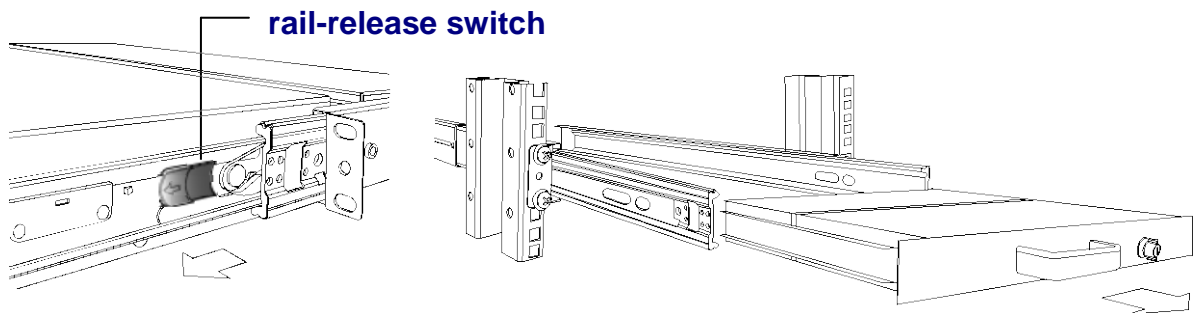

6. Push rail-lock switch on the rail and push rail back.(Both sides)

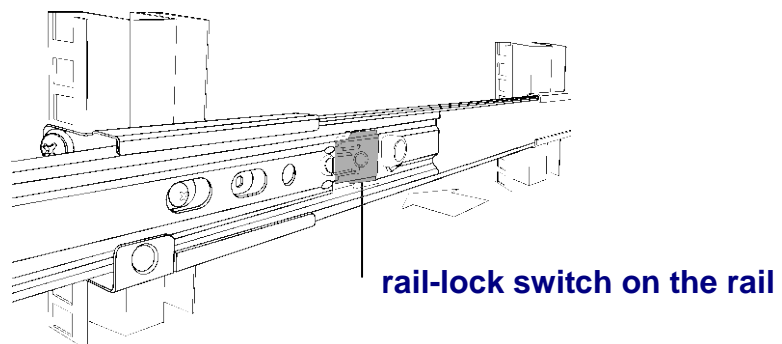

3.3 Installing the Video Card and Video Driver

Before connecting the LCD console, make sure your computer has a video card already installed for the panel. After you connect the console, install the video software driver. The video driver is supplied by the video card manufacturer and may be found on the CD-ROM that came with your computer. If you need information on installing a video card or video driver, refer to the manual that came with your video card.

3.3.1 Configuring the Display Settings

After connecting the console and turning on your computer, you may need to configure one or more of the following display settings:

- Display mode (also called desktop area or video resolution)
- Refresh rate (also called vertical scan rate or vertical sync)
- Color depth (also called color palette or number of colors)

Each video card has several controls that let you adjust the display settings. However, the software and driver for each video card is unique. In most cases, you adjust these settings by using a program or utility provided by the manufacturer of the video card. Most video cards use the Windows Display Properties control panel to configure the display. To open the Windows Display Properties, click the right mouse button in a blank area of the Windows desktop and then select **Properties**. The Settings tab usually lets you change the Color Palette and the Desktop Area (*x by y pixel resolution*).

Some video cards integrate additional features into the Windows Display Properties control panel to give you an exceptional setup that is flexible and easy to use. For example, the control panel may include an Advanced Properties button, an Adjustment tab, or a Refresh tab for changing other settings. Other video cards have a separate utility for setting display properties.

Whenever you change the resolution, color, or refresh rate, the image size, position, or shape may change. This behavior is normal. You can readjust the image using the panel on-screen controls. For more information on the panel on-screen controls, refer to Chapter 2. For more information on configuring the display settings, refer to the manual that came with your video card.

3.3.2 LCD1U17-43 I/O Diagram

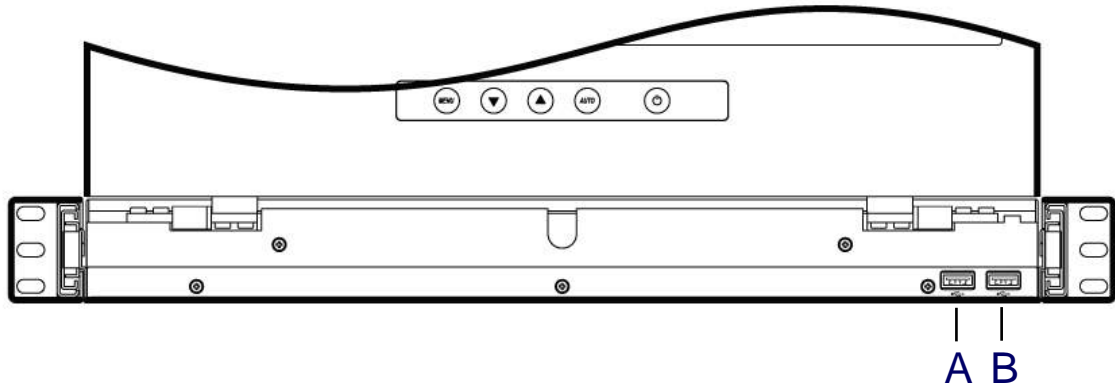

Figure 3-1. LCD1U17-43 Front View (Option)

- A. Front USB port1
- B. Front USB port2

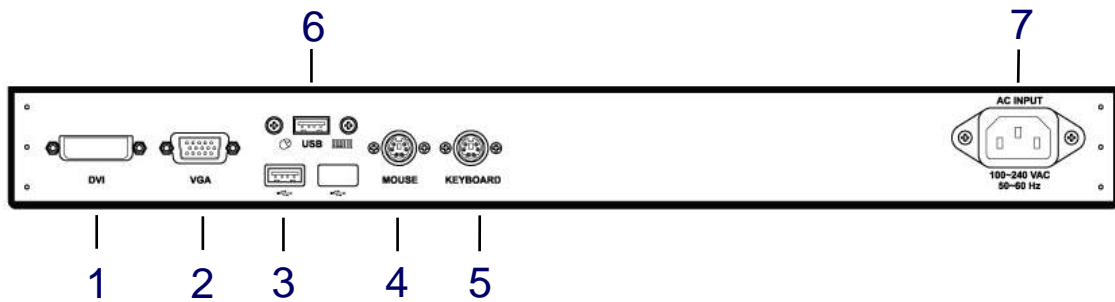

Figure 3-2. LCD1U17-43 Rear View

- 1. DVI port
- 2. VGA port
- 3. USB 2.0 Hub port (option)
- 4. PS/2 mouse
- 5. PS/2 keyboard
- 6. USB Keyboard Mouse Port
- 7. AC in

3.4 Turning on the Console

Make sure all cables and the power cord are connected properly. Be sure to tighten all connector screws. Grab the front handle. Pull the console all the way out then lift the panel up. This will disengage the momentary on/off switch and the unit should power on. The LED on the left or underneath of the panel will be green light.

3.5 Testing the Console

To test that the console is working properly, perform the following steps:

1. Power up the console, and then turn on your computer.
2. Make sure the video image is centered within the screen area. Use the OSD controls to adjust the image (see note below) or press the Auto button on the left or underneath of the panel.



If the unit does not power on when the panel is pulled up, try to push the power on/off button underneath or on the left of the LCD panel to power up the unit.



You can adjust the horizontal and vertical position, contrast, and brightness to better suit your video card and your personal preference. Refer to Chapter 2 for more information on using the on-screen menu to adjust the video display

Before you begin, make sure that powers to all the devices you will be connecting up have been turned off. To prevent damage to your installation due to ground potential difference, make sure that all the devices on the installation are properly grounded. Consult your direct vendor for any technical issues if necessary.

The company reserves the right to modify product specifications without prior notice and assumes no responsibility for any error which may appear in this publication.

All brand names, logo and registered trademarks are properties of their respective owners.

Copyright 2018 Synergy Global Technology Inc All rights reserved.