



Toll Free: 1-888-865-6888



Tel: 510-226-8368 Fax: 510-226-8968

Email: sales@RackmountMart.com

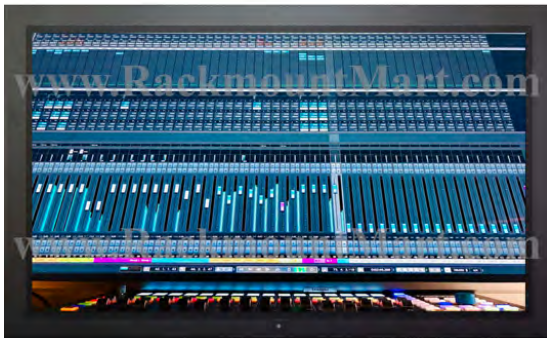
User Manual 31.5" FHD 1920 x 1080 LED-backlit LCD



ID-E43Aw / ID-HE43Aw 
Aluminum front bezel

 **ID-E43AwN / ID-HE43AwN** 
Front NEMA4 / IP65



ID-E43Dw / ID-HE43Dw 
Universal Mounting Open Frame

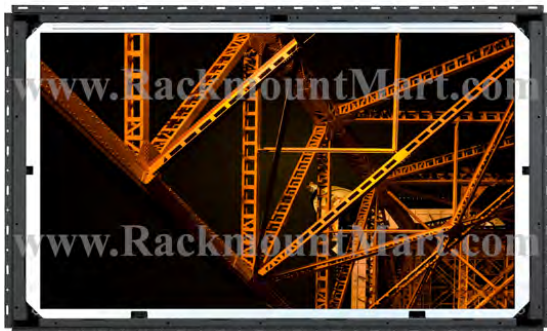

ID-E43Pw / ID-HE43Pw 
Universal Mounting Open Frame

Legal Information

First English printing, January 2024

Information in this document has been carefully checked for accuracy; however, no guarantee is given to the correctness of the contents. The information in this document is subject to change without notice. We are not liable for any injury or loss that results from the use of this equipment.

Safety Instructions

Please read all of these instructions carefully before you use the device. Save this manual for future reference.

- Unplug equipment before cleaning. Don't use liquid or spray detergent; use a moist cloth.
- Keep equipment away from excessive humidity and heat. Preferably, keep it in an air-conditioned environment with temperatures not exceeding 40° Celsius (104° Fahrenheit).
- When installing, place the equipment on a sturdy, level surface to prevent it from accidentally falling and causing damage to other equipment or injury to persons nearby.
- When the equipment is in an open position, do not cover, block or in any way obstruct the gap between it and the power supply. Proper air convection is necessary to keep it from overheating.
- Arrange the equipment's power cord in such a way that others won't trip or fall over it.
- If you are using a power cord that didn't ship with the equipment, ensure that it is rated for the voltage and current labeled on the equipment's electrical ratings label. The voltage rating on the cord should be higher than the one listed on the equipment's ratings label.
- Observe all precautions and warnings attached to the equipment.
- If you don't intend on using the equipment for a long time, disconnect it from the power outlet to prevent being damaged by transient over-voltage.
- Keep all liquids away from the equipment to minimize the risk of accidental spillage. Liquid spilled on to the power supply or on other hardware may cause damage, fire or electrical shock.
- Only qualified service personnel should open the chassis. Opening it yourself could damage the equipment and invalidate its warranty.
- If any part of the equipment becomes damaged or stops functioning, have it checked by qualified service personnel.

What the warranty does not cover

- Any product, on which the serial number has been defaced, modified or removed.
- Damage, deterioration or malfunction resulting from:
 - Accident, misuse, neglect, fire, water, lightning, or other acts of nature, unauthorized product modification, or failure to follow instructions supplied with the product.
 - Repair or attempted repair by anyone not authorized by us.
 - Any damage of the product due to shipment.
 - Removal or installation of the product.
 - Causes external to the product, such as electric power fluctuation or failure.
 - Use of supplies or parts not meeting our specifications.
 - Normal wear and tear.
 - Any other causes which does not relate to a product defect.
- Removal, installation, and set-up service charges.

Regulatory Notices Federal Communications Commission (FCC)

This equipment has been tested and found to comply with the limits for a Class B digital device, pursuant to Part 15 of the FCC rules. These limits are designed to provide reasonable protection against harmful interference in a residential installation.

Any changes or modifications made to this equipment may void the user's authority to operate this equipment. This equipment generates, uses, and can radiate radio frequency energy and, if not installed and used in accordance with the instructions, may cause harmful interference to radio communications.

However, there is no guarantee that interference will not occur in a particular installation. If this equipment does cause harmful interference to radio or television reception, which can be determined by turning the equipment off and on, the user is encouraged to try to correct the interference by one or more of the following measures:

- Re-position or relocate the receiving antenna.
- Increase the separation between the equipment and receiver.
- Connect the equipment into an outlet on a circuit different from that to which the receiver is connected.

Contents

< Part. 1 > ID-E32Aw / E32AwN / HE32Aw / HE32AwN

1.1	Package Content	P.1
1.2	Structure Diagram & Dimension	P.2
1.3	Mounting Hardware & Installation	P.4

< Part. 2 > ID-E32Dw / HE32Dw

2.1	Package Content	P.5
2.2	Structure Diagram & Dimension	P.6
2.3	Mounting Hardware & Installation	P.8

< Part. 3 > ID-E32Pw / HE32Pw

3.1	Package Content	P.9
3.2	Structure Diagram & Dimension	P.10
3.3	Mounting Hardware & Installation	P.12

< Part. 4 > Specifications / OSD / Remote Controller

4.1	Product Specifications	P.14
4.2	On-screen Display Operation (OSD)	P.16
4.3	Picture In Picture (PIP) / Picture By Picture (PBP)	P.18
4.4	Remote Controller	P.20

< Part. 5 > Options

5.1	Option Table	P.21
5.2	3G / HD / SD- SDI Broadcast-grade input	P.22
5.3	MC Multi-display control solution	P.23
5.4	Upgrade : HDMI, DP & Audio	P.24
5.5	Touchscreen & driver	P.25
5.6	DC Power : 24V / 48V / 125V	P.26
5.7	MIL-type or lockable connector	P.27
5.8	Quad display for CCTV	P.28
5.9	Options for Sunlight Readable : Auto Dimming	P.29

Before Installation

- It is very important to mount the equipment in a suitable cabinet or on a stable surface.
- Make sure the place has a good ventilation, is out of direct sunlight, away from sources of excessive dust, dirt, heat, water, moisture and vibration.

Unpacking

The equipment comes with the standard parts shown in package content. Check and make sure they are included and in good condition. If anything is missing, or damaged, contact the supplier immediately.

How To Clean Your LCD Monitor



Caution :

- To avoid the risk of electric shock, make sure your hands are dry before unplugging your monitor from or plugging your monitor into an electrical outlet.
- When you clean your monitor, do not press down on the LCD screen. Pressing down on the screen can scratch or damage your display. Pressure damage is not covered under warranty.
- Use only cleansers made specifically for cleaning monitors and monitor screens. Cleansers not made to clean monitors and monitor screens can scratch the LCD display or strip off the finish.
- Do not spray any kind of liquid directly onto the screen or case of your monitor. Spraying liquids directly onto the screen or case can cause damage which is not covered under warranty.
- Do not use paper towels or abrasive pads to clean your monitor. Using an abrasive pad or any wood based paper product such as paper towels can scratch your LCD screen.

Cleaning Your Monitor

To clean your LCD safely, please follow these steps :

- ① Disconnect the power cord.
- ② Gently wipe the surface using a clean, dry microfiber cloth. Use as little pressure as possible.

Cleaning Tough Marks and Smudges

To remove tough marks and smudges, please follow these steps :

- ① Disconnect the power cord.
- ② Spray a small amount of non-abrasive cleanser on a microfiber cloth.



Caution : Do not spray or apply any liquids directly onto the monitor. Always apply the solution to your microfiber cloth first, not directly on the parts you are cleaning.

- ③ Gently wipe the surface. Use as little pressure as possible.
- ④ Wait until your monitor is completely dry before plugging it in and powering it up.

**ID-E32Aw / ID-E32AwN
ID-HE32Aw / ID-HE32AwN**

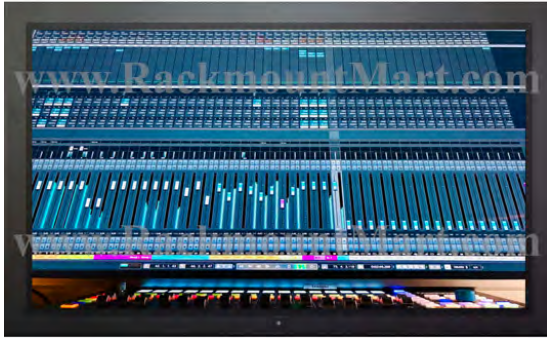

- 31.5" FHD LCD display X 1
- 6ft VGA cable X 1
- Power cord X 1
- Remote controller X 1

Basic I/O

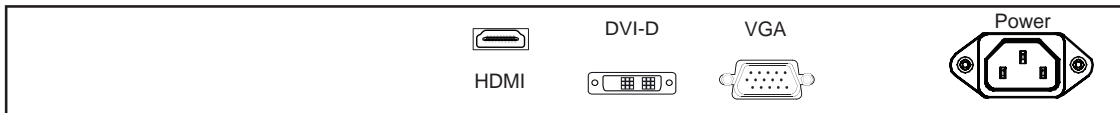

Upgrade I/O with advanced features

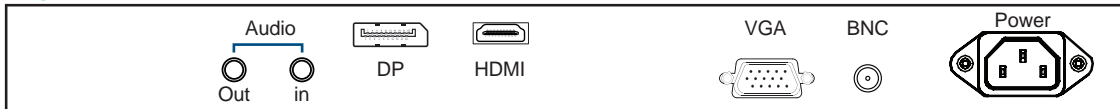

< 1.2 > Structure Diagram

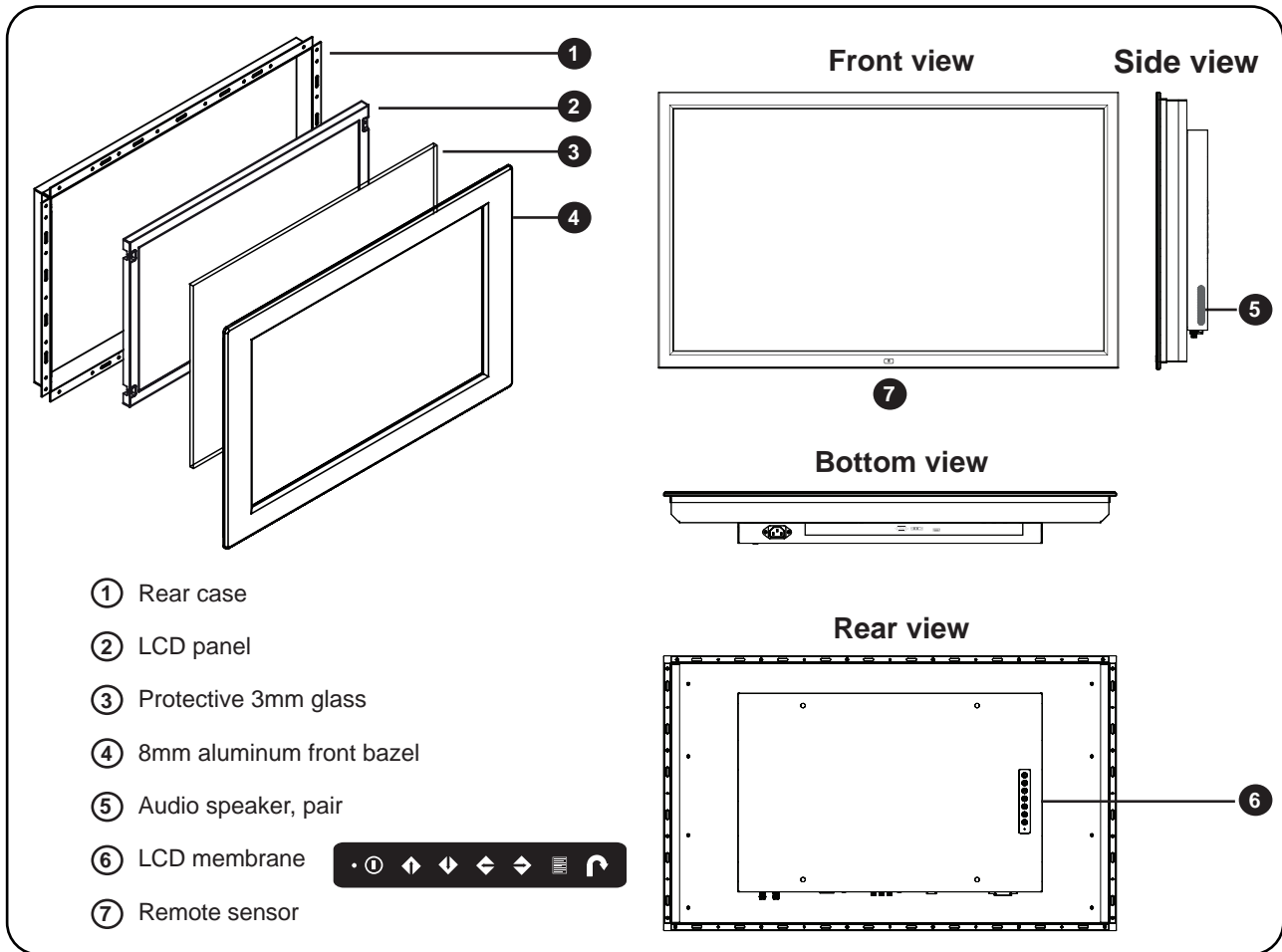

Model	Product Dimension (W x D x H)	Net Weight
ID-E32Aw ID-E32AwN	780 x 88.2 x 474 mm 30.7 x 3.5 x 18.7 inch	20.9 kg 46 lb
ID-HE32Aw ID-HE32AwN		23.9 kg 52.6 lb

< 1.2 > Dimension

31.5" FHD Display

Front View

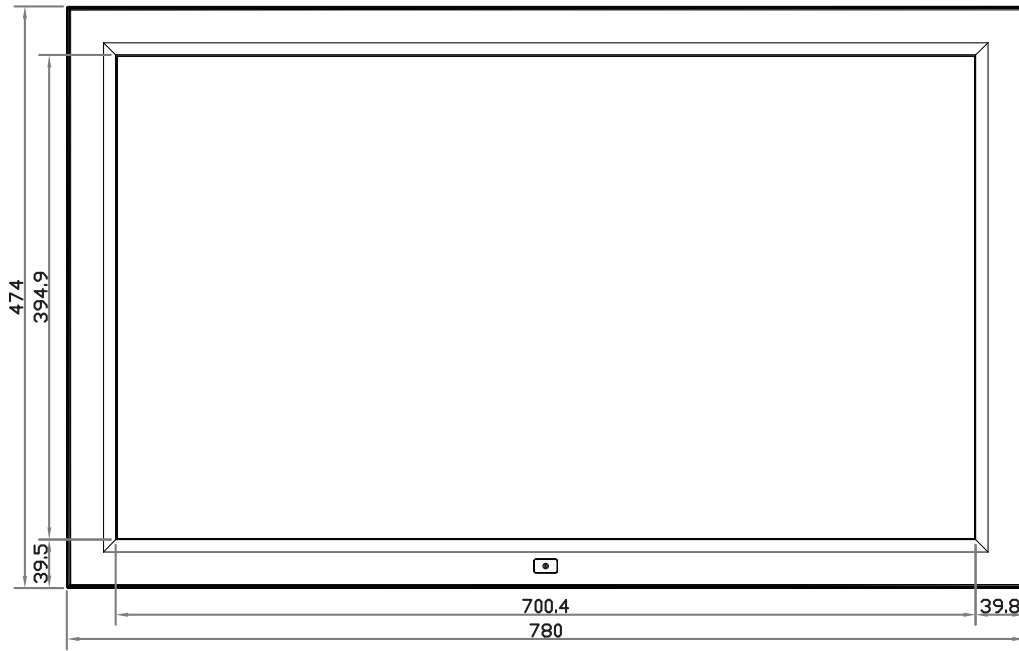

Side View

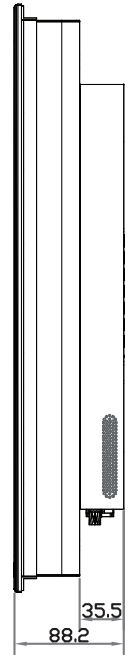

Rear View

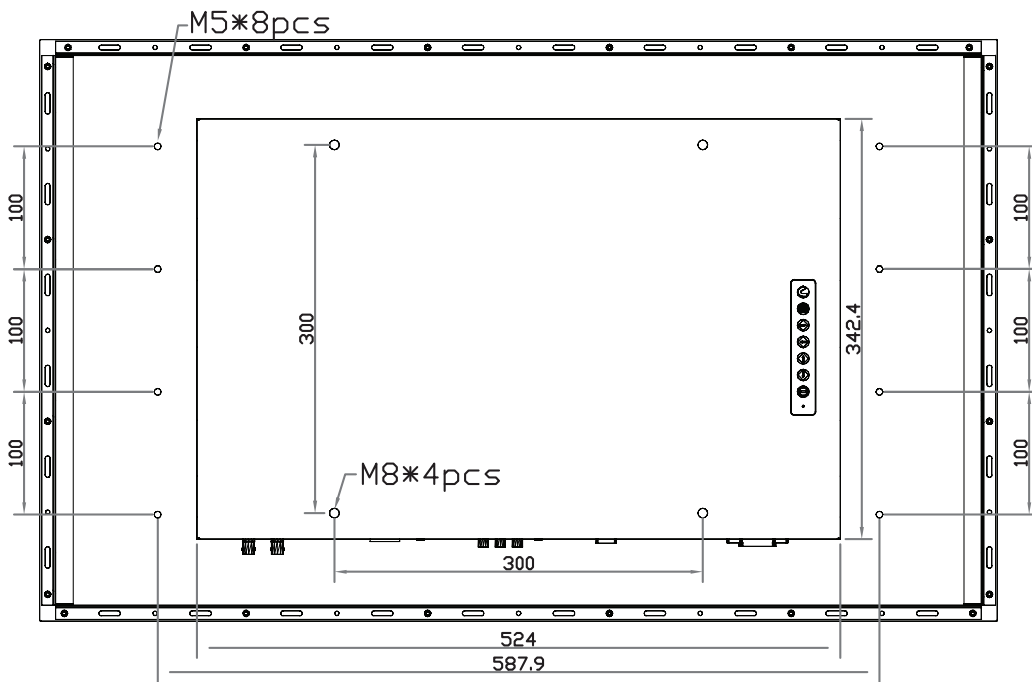

UNIT : mm
1mm = 0.03937 inch

Bottom View

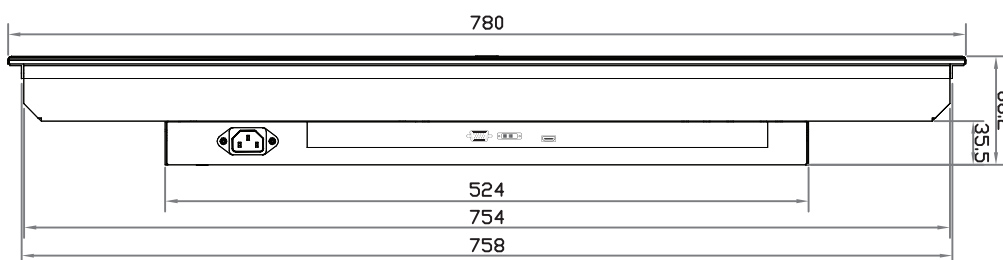

< 1.3 > VESA Installation

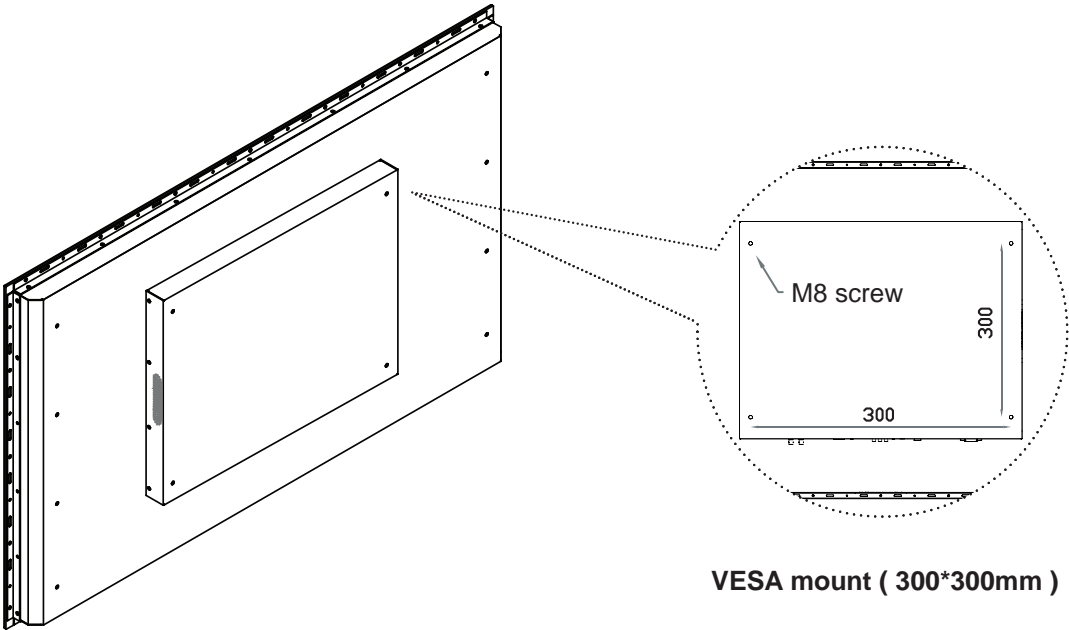

VESA mount (300*300mm)

- Hardware and M8*4 pcs for VESA mount are not provided

ID-E32Dw / ID-HE32Dw



- 31.5" FHD LCD display X 1
- 6ft VGA cable X 1
- Power cord X 1
- Remote controller X 1

Basic I/O

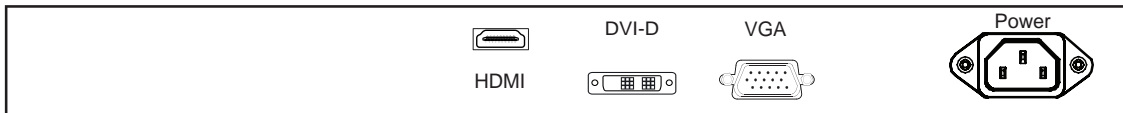

Upgrade I/O with advanced features



< 2.2 > Structure Diagram

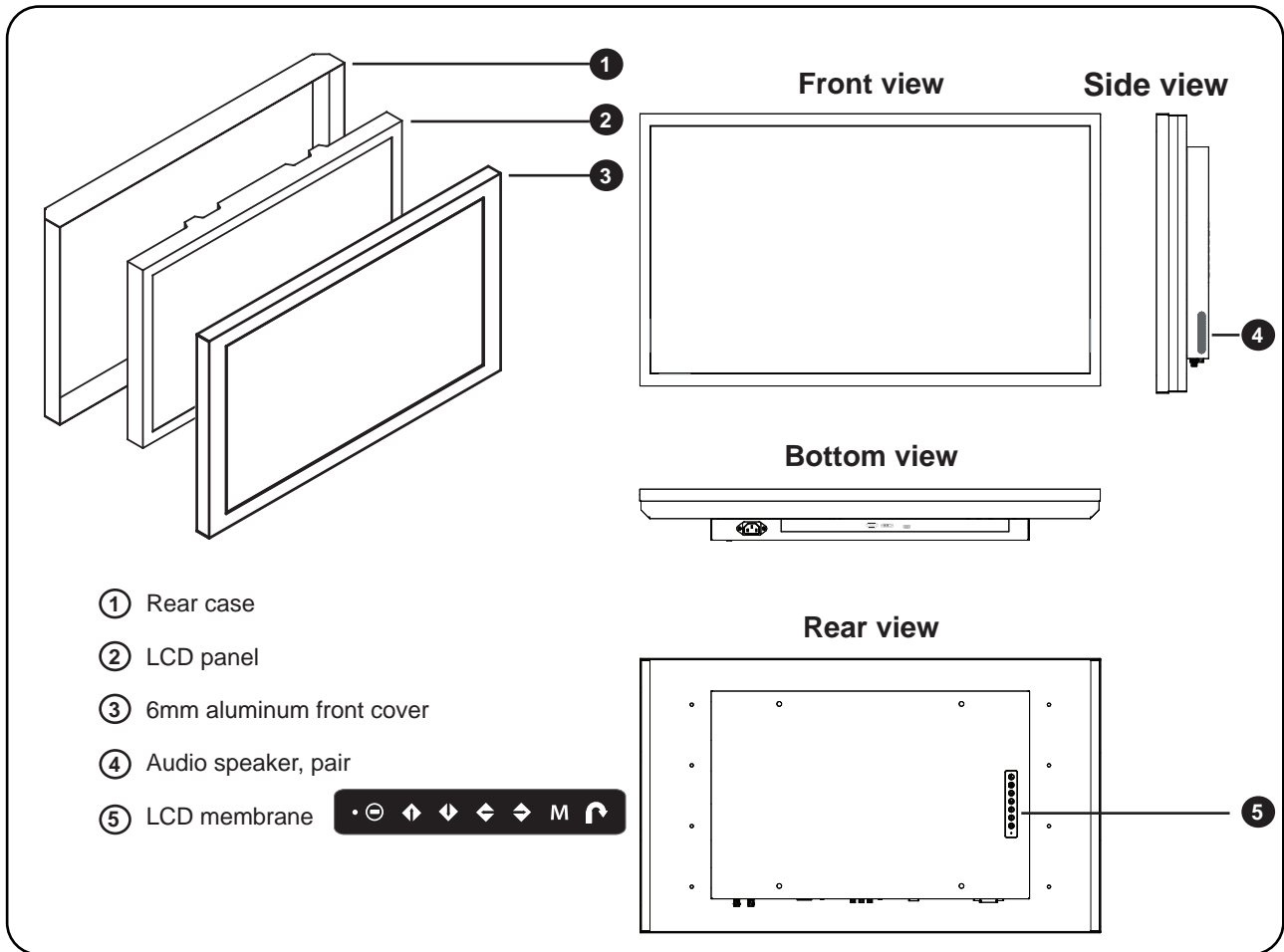

Model	Product Dimension (W x D x H)	Net Weight
ID-E32Dw ID-HE32Dw	758 x 84.2 x 452 mm 29.8 x 3.3 x 17.8 inch	18.7 kg 41.1 lb

< 2.2 > Dimension

31.5" FHD Display

Front View

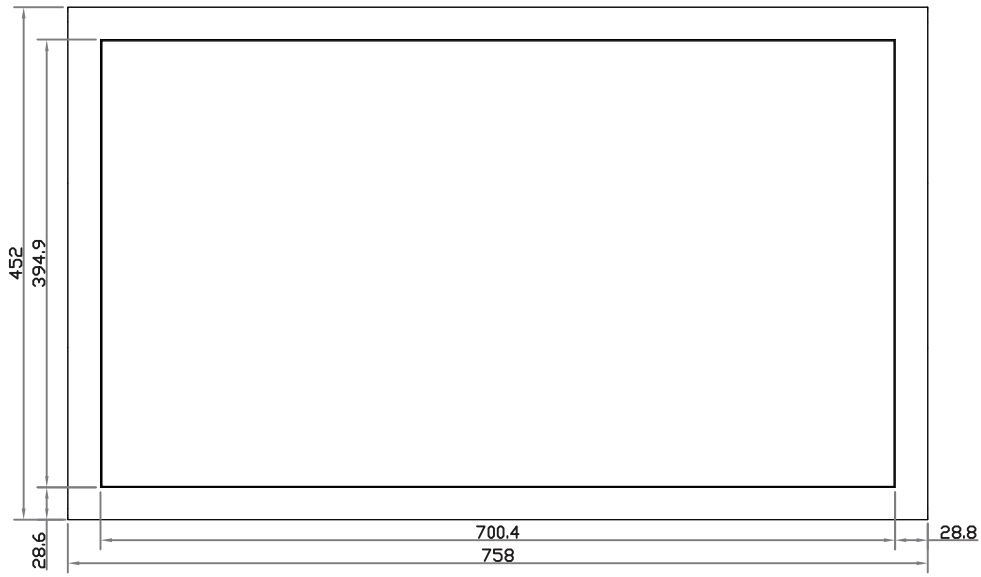

Side View

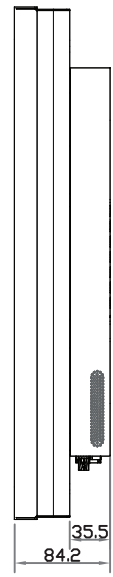

Rear View

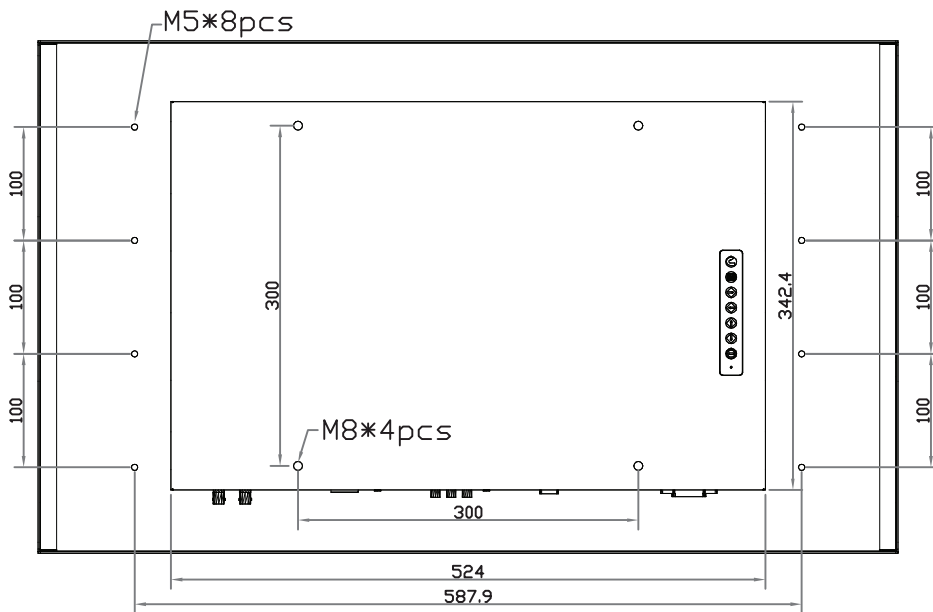

UNIT : mm
1mm = 0.03937 inch

Bottom View

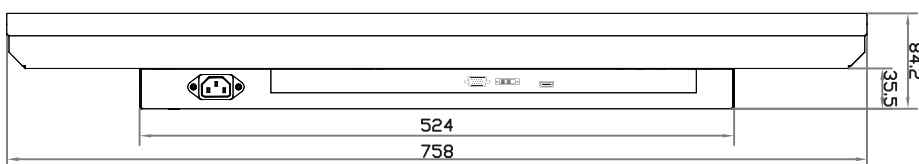

< 2.3 > VESA Installation

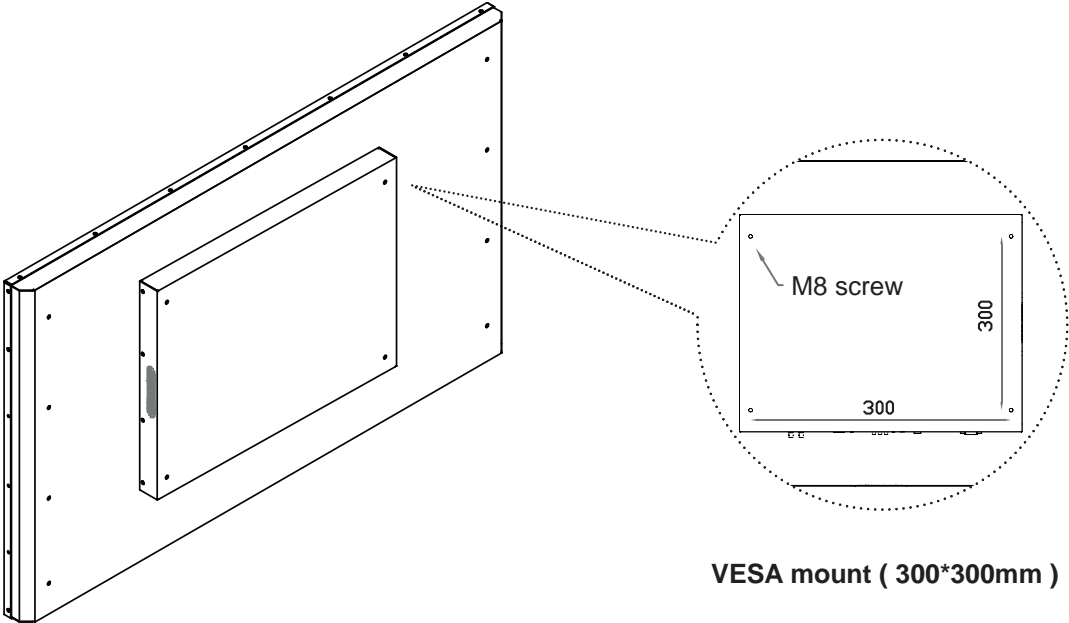

VESA mount (300*300mm)

- Hardware and M8*4 pcs for VESA mount are not provided

ID-E32Pw / ID-HE32Pw



- 31.5" FHD LCD display X 1
- 6ft VGA cable X 1
- Power cord X 1
- Remote controller X 1

Basic I/O

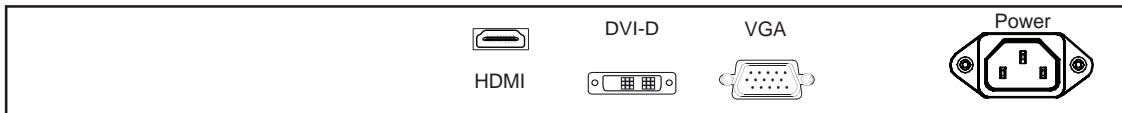

Upgrade I/O with advanced features



< 3.2 > Structure Diagram

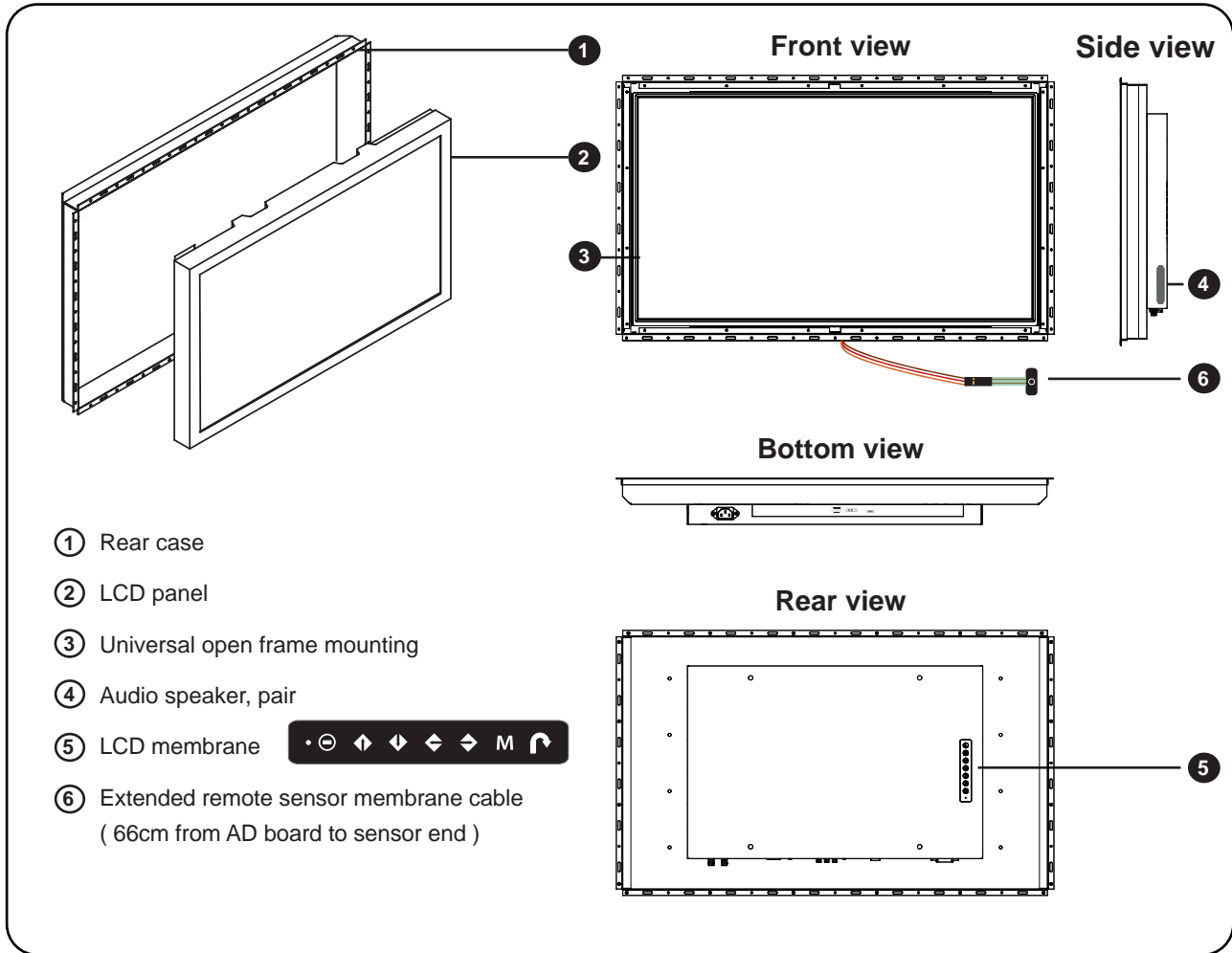

Model	Product Dimension (W x D x H)	Net Weight
ID-E32Pw ID-HE32Pw	777 x 82.2 x 471 mm 30.6 x 3.2 x 18.5 inch	16.4 kg 36.1 lb

< 3.2 > Dimension

31.5" FHD Display

Front View

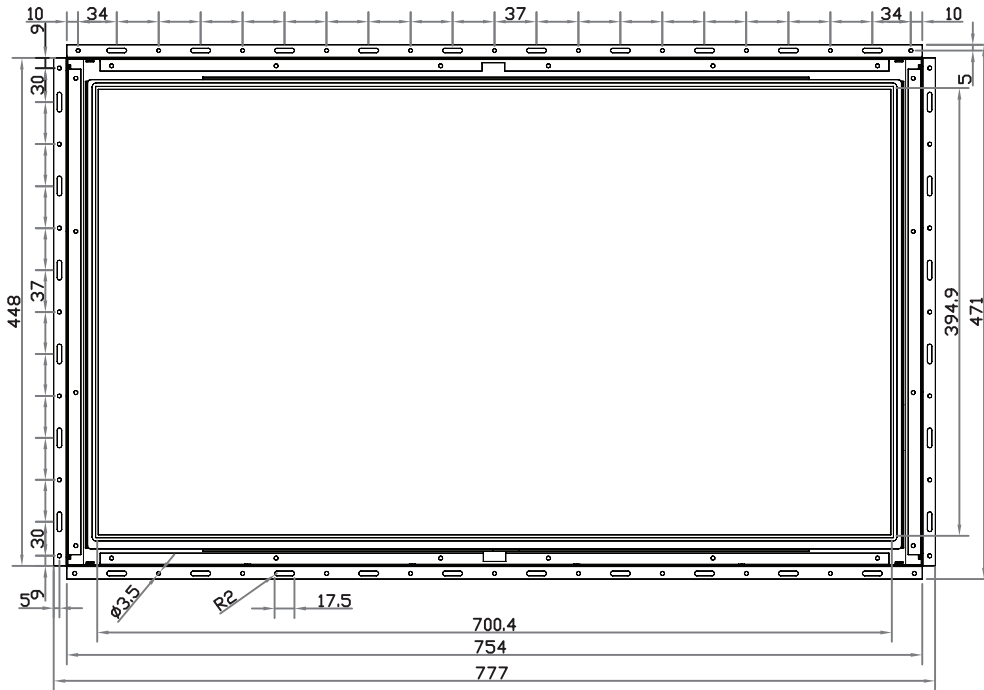

Side View

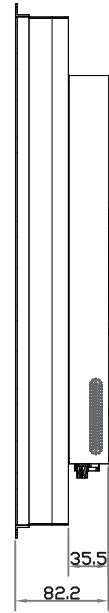

Rear View

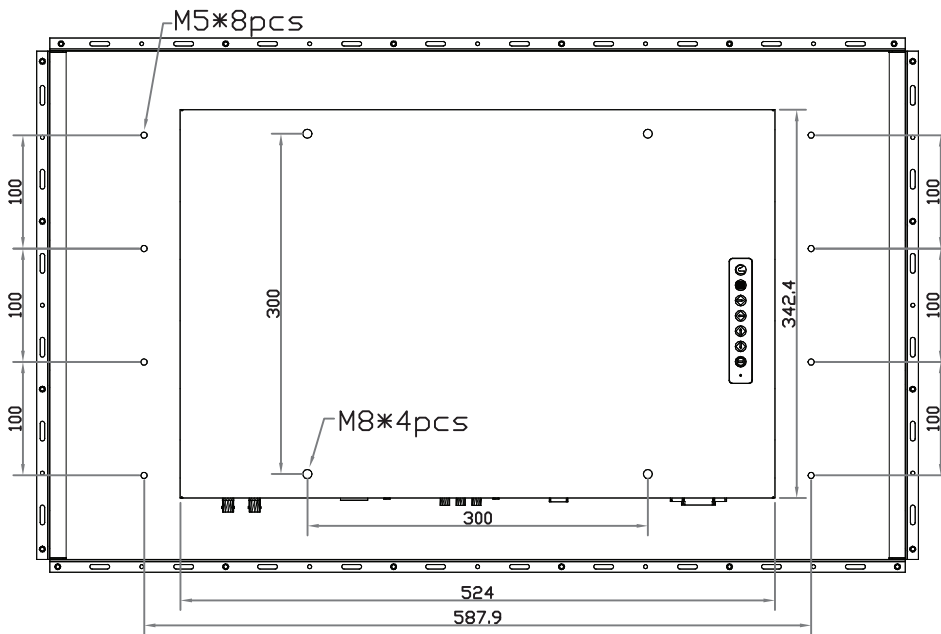

UNIT : mm
1mm = 0.03937 inch

Bottom View

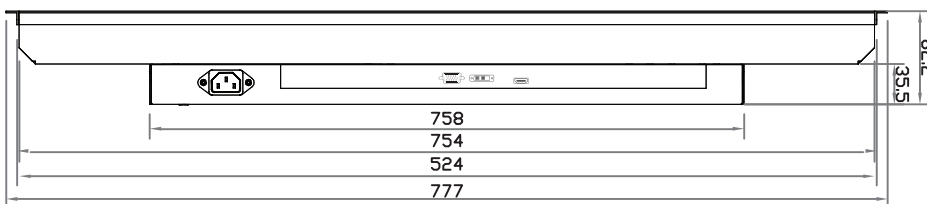

< 3.3 > Installation

(I) Universal mount

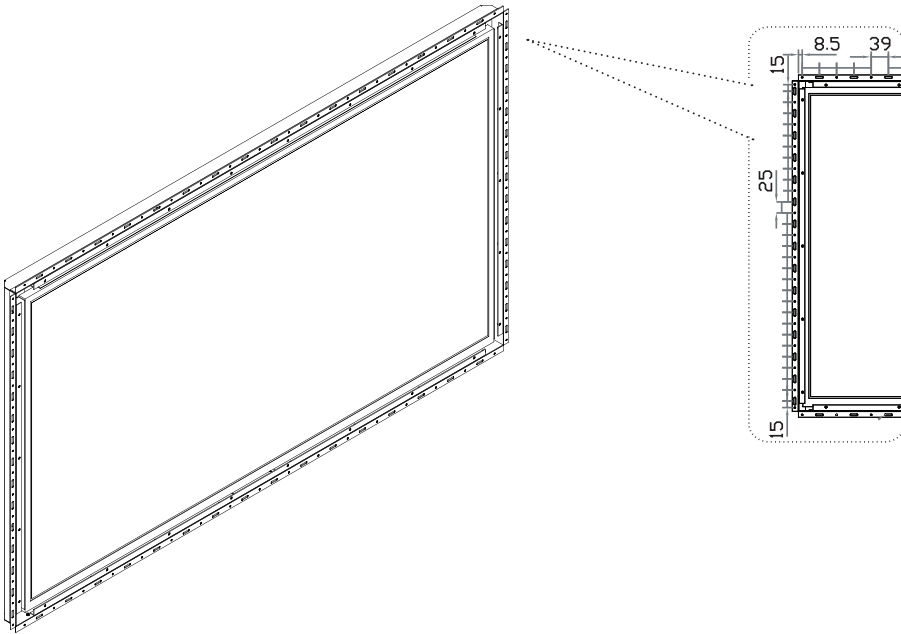

(II) VESA mount (300*300mm)

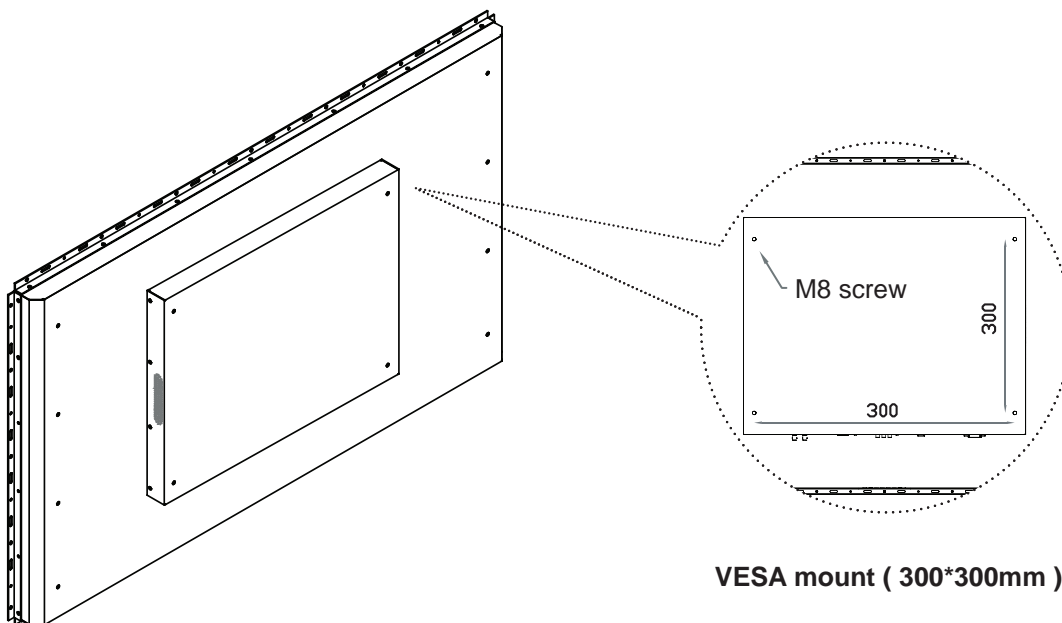

VESA mount (300*300mm)

■ Hardware and M8*4 pcs for VESA mount are not provided

< Part 4 >

< 4.1 > Product Specifications

Mechanical Design	ID-E32Aw / ID-HE32Aw	ID-E32AwN / ID-HE32AwN	ID-E32Dw / ID-HE32Dw	ID-E32Pw / ID-HE32Pw
Protection	8mm front bezel	NEMA 4 / IP65	front cover	open frame
Front Panel	Black, RAL 9005			-
Rear Casing	Black, RAL 9005			
VESA mount	300 x 300 mm			
Universal mount	-	-	-	ready
Overhead tilted wall-mount	option	option	option	-
Desktop stand	option	option	option	-

LED-backlit LCD Panel	Standard	Sunlight Readable
Brightness (cd/m ²)	350	1500 
Contrast Ratio (typ.)	1200 : 1	3000 : 1
MTBF (hrs)	30,000	50,000
Panel Size (diagonal)	31.5-inch Widescreen TFT color LCD	
Native resolution	1920 x 1080	
Colors	16.7M, 8-bit	
Viewing Angle (L/R/U/D)	89/89/89/89	
Response Time (ms)	8	20
Dot pitch (mm)	0.363	
Display Area (mm)	698.4H x 392.85V	
Surface treatment	Anti-glare	
Surface hardness	3H	
Backlight Type	LED	

Video	
VGA	Analog 0.7Vp-p
DVI	DVI-D single link
HDMI	HDMI 1.4 / HDCP 1.4
Option Display port	DP 1.0 / HDCP 1.3
Composite (BNC)	NTSC & PAL

Audio Option	
Input Connector	3.5mm stereo jack
Impedance / Power level	30kΩ / 750mV
Output Connector	3.5mm stereo jack
Resistance / Power level	30kΩ / 2.8V
Speaker: Dual Stereo	10W x 2

*When the audio output is connected, speaker output is OFF

Power	Standard	Sunlight Readable
Input	Auto-sensing 100 to 240VAC, 50 / 60Hz	
Consumption:		
Screen ON	Max. 56W	Max. 160W
Power saving mode	Max. 9W	Max. 9W
Power button OFF	Max. 2W	Max. 2W

Compliance	
EMC	FCC & CE
Safety	CE / LVD & UKCA
Environment	RoHS3 & REACH / WEEE

Environmental Conditions		
Operating	Temperature	:0 to 55°C degree
	Humidity	:10~90%, non-condensing
	Altitude	:16,000 ft
Storage / Non-operating	Temperature	:-20 to 60°C degree
	Humidity	:5~90%, non-condensing
	Altitude	:40,000 ft
	Shock	:10G acceleration (11ms duration)
	Vibration	:10~300Hz 0.5G RMS random vibration

Physical Specification	ID-E32Aw / ID-HE32Aw	ID-E32AwN / ID-HE32AwN	ID-E32Dw / ID-HE32Dw	ID-E32Pw / ID-HE32Pw
Product (W x D x H)				
mm	780 x 88.2 x 474		758 x 84.2 x 452	777 x 82.2 x 471
inch	30.7 x 3.5 x 18.7		29.8 x 3.3 x 17.8	30.6 x 3.2 x 18.5
Net Weight	20.9 kg / 46 lb	23.9 kg / 52.6 lb	18.7 kg / 41.4 lb	16.4 k g / 36.1 lb
Chassis color	Dark			
Chassis materials	Aluminum			

* All dimensions stated are subject to change if options are selected / integrated to base model part codes

Applicable Format			
DVI-D / VGA Input	PC Signal	:1920 x 1080 x 60Hz	
		:1360 x 768 x 60Hz	
		:1280 x 1024 x 60 / 75Hz	
		:1280 x 960 x 60Hz	
		:1280 x 768 x 60 / 75Hz	
		:1152 x 864 x 75Hz	
		:1024 x 768 x 60 / 70 / 75Hz	
		:848 x 480 x 60Hz	
		:800 x 600 x 60 / 72 / 75Hz	
		:720 x 400 x 70Hz	
		:640 x 480 x 60 / 72 / 75Hz	
		:640 x 400 x 70Hz	
		:640 x 350 x 70Hz	
HDMI Input	Audio Signal	:2ch Linear PCM	
	PC Signal	:Same as VGA	
	HDMI 1.4	:1920 x 1080 x 50 / 60Hz (1080p)	
		:1920 x 1080 x 25 / 30Hz (1080i)	
		:1280 x 720 x 50 / 60Hz (720p)	
:720 x 480 x 50 / 60Hz (576p / 480p)			
Display port Input	PC Signal	:2ch Linear PCM	
		:1920 x 1080 x 60Hz	
		:1600 x 1200 x 60Hz	
		:1360 x 768 x 60Hz	
		:1280 x 768 x 60 / 75Hz	
		:1280 x 768 x 60Hz	
		:1024 x 768 x 60 / 70 / 75Hz	
		:800 x 600 x 60 / 72 / 75Hz	
		:720 x 400 x 70Hz	
		:640 x 480 x 60 / 72 / 75Hz	
		Audio Signal	:2ch Linear PCM

< 4.2 > On-screen Display Operation (OSD)

- Power light
- Green = On
- Orange = Power saving

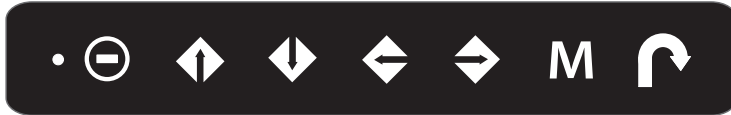

Membrane Switch	Function
	Power on / off LCD
	Display the OSD menu
	Scrolls through menu options and adjusts the displayed control (To auto adjustment by pressing the button for 5 seconds)
	Exit the OSD screen Toggle analog, digital & video connection (DVI-D and video options only)

① Picture

- Brightness : Adjust the screen brightness
- Contrast : Adjust the difference between the image background (black level) and the foreground (white level)
- Black level : Adjust background black level of the screen
- Eco : Screen in power saving mode



② Position

- H-Position : To adjust the horizontal position of the video
- V-Position : To adjust the vertical position of the video
- Clock : To auto adjust H. Size of the screen
- Phase : To fine tune the screen.
- Picture size : FULL SCREEN / 4:3 / 5:4 / 16:10

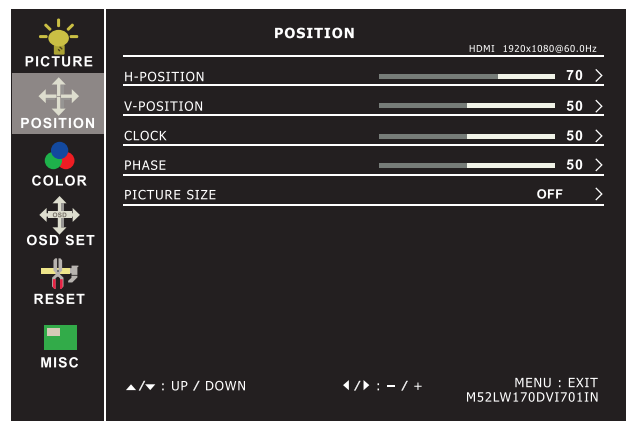

< 4.2 > On-screen Display Operation (OSD)

31.5" FHD Display

③ Color

Color temperature: User / Warm / Cool / 5400k mode and Red / Green / Blue color balance

Sharpness : Adjust the image from weak to sharp

Hue : Adjust the screen hue value

Saturation : Adjust the saturation of the image color

Dynamic

luminous control : Control the dynamic brightness

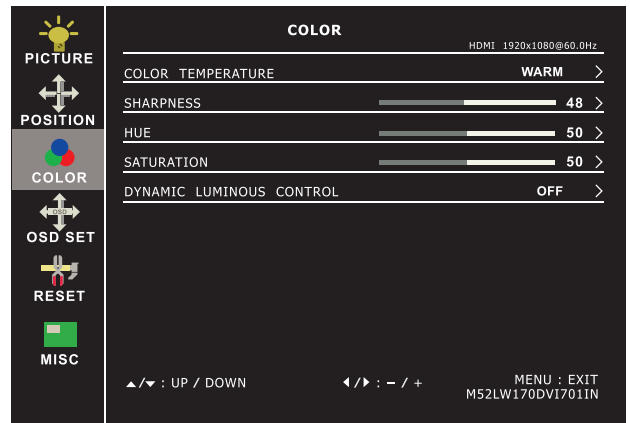

④ OSD Set

Language : Select the language in which the OSD menu is displayed - English

OSD H-Position : Align the screen image left or right

OSD V-Position : Align the screen image up or down

OSD time out : Adjust the screen timeout

OSD transparency : Adjust the screen transparency

OSD rotation : Rotate the screen - 90° / 180° / 270°

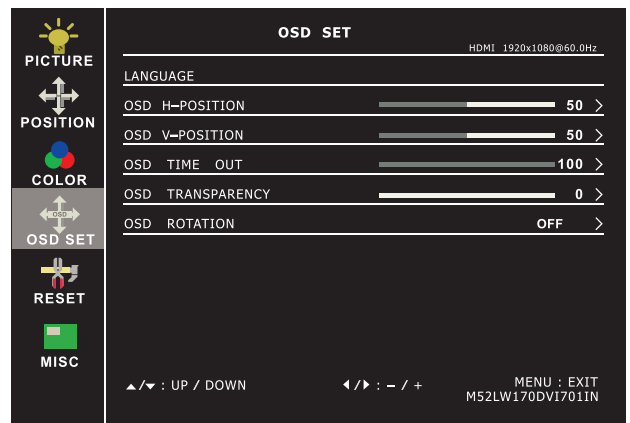

⑤ Reset

Reset : Return the adjustment back to factory setting

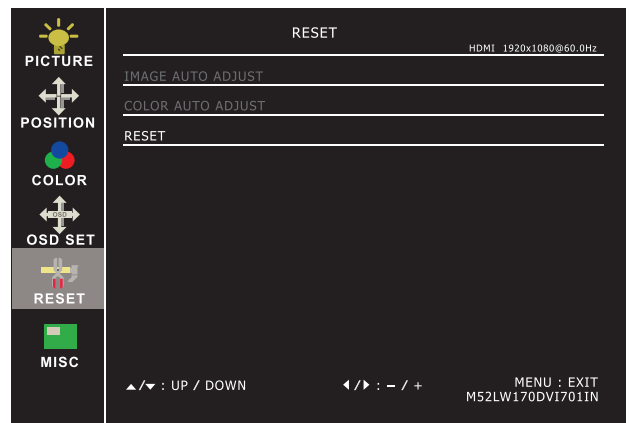

⑥ MISC

Signal source : Select the signal source - DP / HDMI1 / HDMI2

Mute : Turn off the surrounding sound

Audio in : Auto / Line in / DP

Volume : Adjust the volume of sound

Sleep mode : Set the off time - 10 min / 20 min / 30 min / 50 min / 60 min / 120 min / 240 min

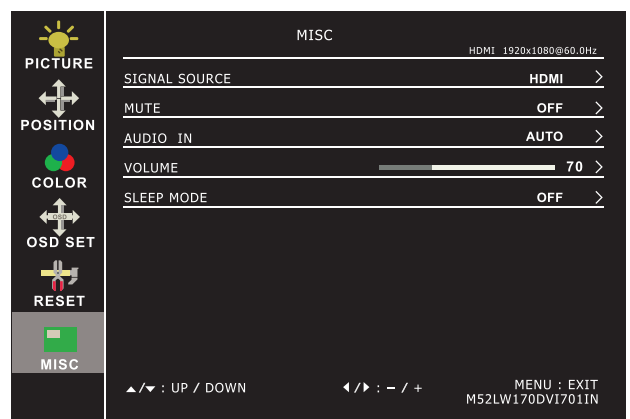

< 4.3 > How to Use Picture In Picture (PIP) / Picture By Picture (PBP)

< 4.3.1 > Picture in Picture (PIP)

Mode

Display the Sub screen in the Main screen.

OSD Menu → MISC → PIP Mode → Large / Small / OFF

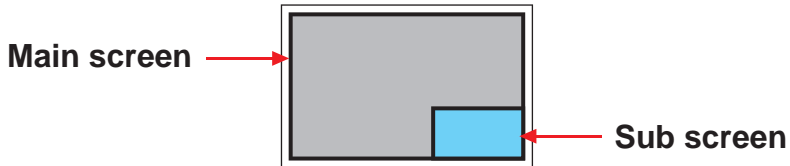

Position

Adjust the position of the Sub screen (top left, bottom left, top right, bottom right)

OSD Menu → MISC → PIP Position → top left / top right / bottom left / bottom right

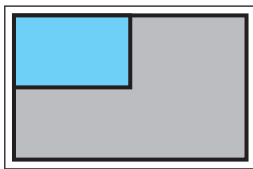

top left

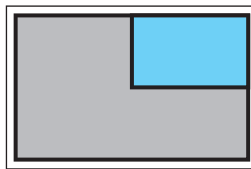

top right

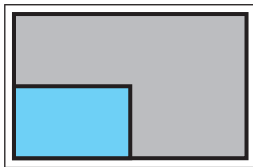

bottom left

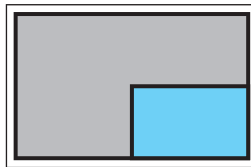

bottom right

Size

Adjust the size of the Sub screen (Large / Small)

OSD Menu → MISC → PIP Mode → Large / Small

Size of Sub screen

LCD Monitor	Large Sub screen	Small Sub screen
1920 x 1200	552 x 414	480 x 360
1920 x 1080	552 x 414	480 x 360
1440 x 900	414 x 310	360 x 270
1366 x 768	392 x 294	340 x 254
1280 x 1024	368 x 276	320 x 240

< 4.3.2 > Picture By Picture (PBP)

Mode

Display the Sub screen next to the Main screen.

OSD Menu → MISC → PIP Mode → PBP



Size

LCD Monitor	Main / Sub screen
1920 x 1200	955 x 716
1920 x 1080	955 x 716
1440 x 900	715 x 536
1366 x 768	678 x 508
1280 x 1024	635 x 476

< 4.3.3 > PIP / PBP Source

To select an input signal for PIP / PBP Sub screen.

OSD Menu → MISC → PIP Source → HDMI / SDI

The PIP / PBP is operable in the following table :

Main \ Sub	HDMI	SDI
HDMI	X	O
SDI	O	X

< 4.4 > Remote Controller

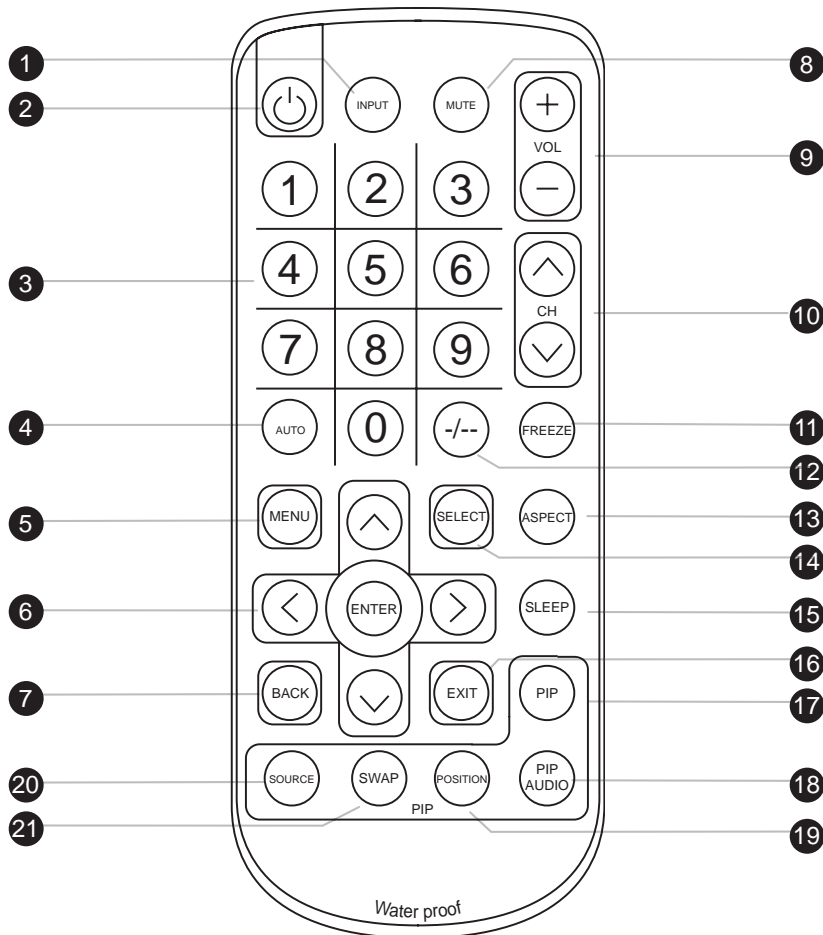

①	INPUT	Select the source
②	⏻	Switches on or off the TV
③	0 - 9	Only use in TV mode. Select channels. For channel numbers 10 and above, enter the second digit within two seconds.
④	AUTO	Auto adjust
⑤	MENU	Display the menu on the screen or go to the previous menu
⑥	▲ / ▼ / ◀ / ▶ / ENTER	Go to the upper menu or select the previous value / Go to the next menu or select the next value / Decrease the setting value / Increase the setting value or enter to the select item setting Enter to the select item settings or excude the setting
⑦	BACK	Back to previous value
⑧	MUTE	Turn on or off the speaker
⑨	Vol +/-	Increase or decrease the speaker volume
⑩	CH +/-	For TV model only, increase or decrease the channel number
⑪	FREEZE	Reserve for OEM model
⑫	-/--	For setting input single or double digits
⑬	ASPECT	Adjust the screen size
⑭	SELECT	To select the existing item
⑮	SLEEP	Select the sleeping time
⑯	EXIT	Exit the menu or cancel
PIP functions		
⑰	PIP	Picture in picture
⑱	PIP AUDIO	To set the audio of in PIP mode
⑲	POSITION	To set the screen position in PIP mode
⑳	SOURCE	PIP Source
㉑	SWAP	Swap screen in PIP mode

< Part 5 > Options

< 5.1 > Option Table

31.5" FHD Display

Options	Aw / AwN	HAw / HAwN	Dw	HDw	Pw	HPw
SDI	✓	✓	✓	✓	✓	✓
MC multi-screen control	✓	✓	✓	✓	✓	✓
Touchscreen	✓	✓	✓	✓	✓	✓
DC Power	✓	✓	✓	✓	✓	✓
MIL-type / lockable connector	✓	✓	✓	✓	✓	✓
Quad display	✓	✓	✓	✓	✓	✓
Auto / switch dimming		✓		✓		✓

< 5.2 > Options : 3G / HD / SD-SDI input



Our SDI input is an ideal solution for the broadcast-grade video and high resolution CCTV market.

Designed for use with NOVA series displays, a SDI input module can support up to 1080p @60Hz resolution without using additional space or power and it comes standard with a 1-year warranty.

* SDI option comes with speakers & remote controller.

SDI

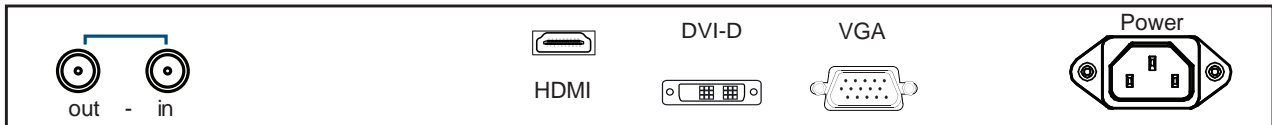

INPUT	3G-SDI IN	BNC x 1 / 0.8Vp-p (75 ohm)
	3G-SDI OUT	BNC x 1 / Active through, equalized & relocked

Standard Compliance	Video	SMPTE 425M / 274M / 296M / 125M ITU-R BT.656
	Audio	SMPTE 299M / 272M-C

Compatible Video Format	3G-SDI	1080p @60 / 50Hz, 4:2:2
		1080p @30 / 25 / 24Hz, 4:4:4
		1080i @60 / 50Hz, 4:4:4
		720p @60 / 50Hz, 4:4:4
	HD-SDI	1080p @30 / 25 / 24Hz, 4:2:2
		1080i @60 / 50Hz, 4:2:2
		720p @60 / 50Hz, 4:2:2
SD-SDI	480i @60Hz, 4:2:2	
ITU-R BT.656	576i @50Hz, 4:2:2	

Compatible Audio Format	3G-SDI	48kHz, 16 / 20 / 24 bit, 2 CH, Synchronized Video
	HD-SDI	48kHz, 16 / 20 / 24 bit, 2 CH, Synchronized Video
	SD-SDI	48kHz, 16 / 20 / 24 bit, 2 CH, Synchronized / Asynchronous Video

Max. Transmission Distance 75 ohm coaxial cable	3G-SDI	150m at 2.97Gb/s
	HD-SDI	250m at 1.485Gb/s
	SD-SDI	480m at 270Mb/s

< 5.3 > Options : MC

31.5" FHD Display

MC

(Multi-display Control)

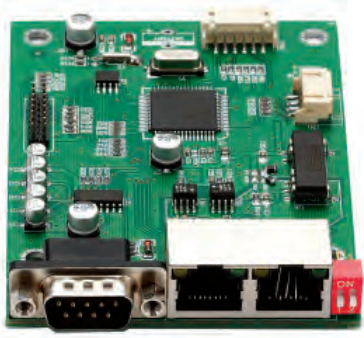

More control is always good. Especially when it is necessary and easy. Synergy Global Technology provides MC solution to control the OSD of various Industrial LCD displays up to 64 units.

The RS-232C is used for the communication between the PC and the first display via a 15 feet serial cable while the CAN bus is used for the various LCD displays cascade together via CAT 5/6 cable, and daisy chain up to 1,000 meters.

Designed for use with our Industrial LCD displays, we provide a MC input module without using additional space or power.

MC

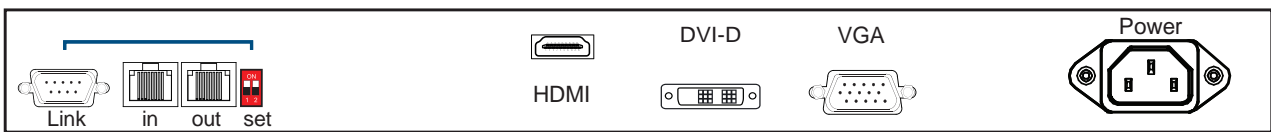

*** Please download the protocol of MC control at : <https://www.rackmountmart.com/downloads.html>

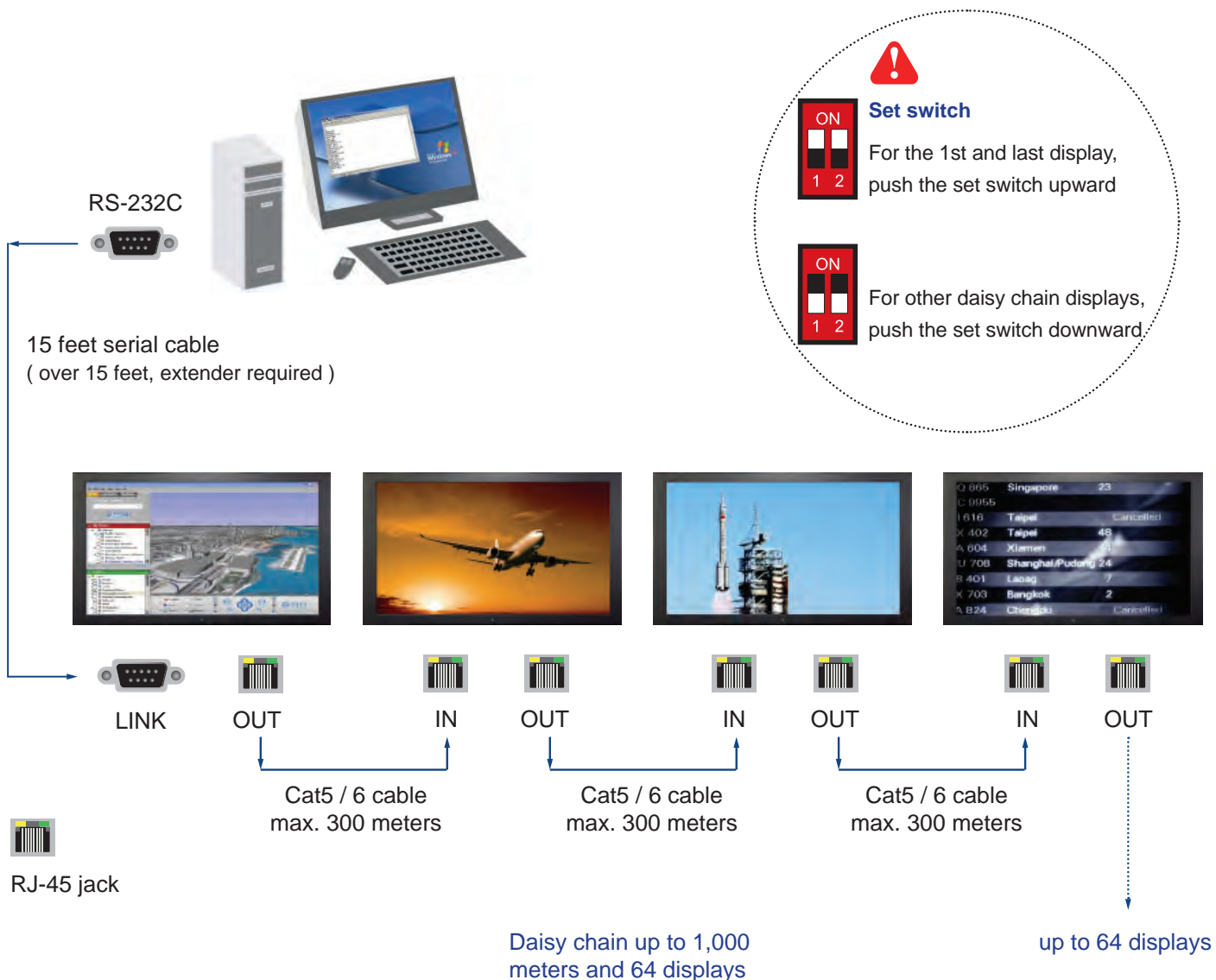

< 5.4 > Upgrade Options :

- **Display Port** (DP 1.0, HDCP 1.3)
- **Audio** (Built-in Dual Stereo Speakers, 2W x 2)
(3.5mm audio jacks for audio in & out)





31.5" USB Touchscreen Specification

Model	TPC Multi-touch	IR10 Multi-touch
Technology	Projected Capacitive	Infrared
Touch Point	10	10
Input Type	Finger or Capacitive Stylus	Pen, Finger, Finger of gloved hand activation
Resolution	4096 x 4096	-
Touch Point Accuracy	± 2 mm	± 2 mm
Response Speed	< 5 ms	≤ 15 ms
Activation Force	< 5 g	No minimum touch activation force
Surface Hardness	6H	-
Light Transmission	> 85%	-
Haze	3% ↓	-
Durability	50 million touches	Unlimited
Top Layer	1.1 mm Glass	3 mm
Bottom Layer	0.7 mm Sensor Glass	-
Thickness	2 mm	-
Connector	USB	A-type USB
Compatibility	Linux / Android / Windows / Mac	Windows 7 / Windows 10

- Dimension will be changed if touchscreen required
- USB touchscreen package includes 1 x 6ft USB cable, quick reference guideline and CD disc
- For detailed information, please refer to the attached CD disc
- As the touchscreen unit is not made of toughened glass, please handle it carefully

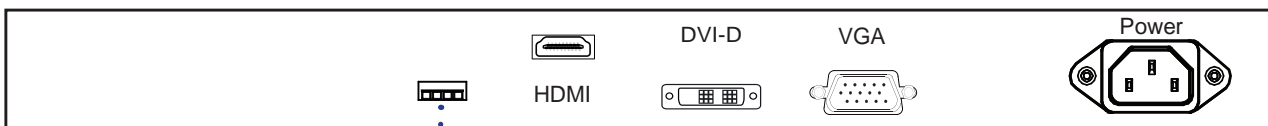

USB Touchscreen

IR10 Driver



Connect the USB cable from the USB port on the LCD to a computer. The touch screen supports easy Plug-and-Play operations. There is no need to install additional drivers on the computer.

< 5.6 > Options : DC Power

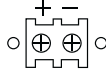



Model	24V	48V	125V
Input rating			
Input voltage:	24-Volt	48-Volt	110-Volt
Input range:	18 ~ 36V	36 ~ 75V	43 ~ 160V
Input current			
- No load	100 mA	50 mA	10 mA
- Full load	7386 mA	3611 mA	1540 mA
Output rating			
Output voltage:	24-Volt	24-Volt	24-Volt
Output current:	6.25A	6.25A	6.25A
Efficiency	88%	90%	89%

*** For DC power option :

(1) If the unit with LCD, earthing may be required 

	Input	Part no.	MIL Standard
MIL - type Connector	DC Power *** (Male)	MS3470W8-33P 	MIL - DTL - 26482
	VGA *** (Male)	MS3470W14-15P 	MIL - DTL - 26482

*** There are several additional MIL DC and VGA connector types with varying design characteristics to meet cost considerations and to provide users with the most design flexibility possible. For more information, please contact us.

	Input	Part no.	Standard
Lockable Connector	DC Power (Male)	YM-Ext-461CP001 	D-type 3W3
	USB	LUSB - A111 - 00 	-

*** MIL - type or Lockable connectors above can be integrated with our LCD displays. Sale service just for connectors not provided.

< 5.8 > Options : Quad Display

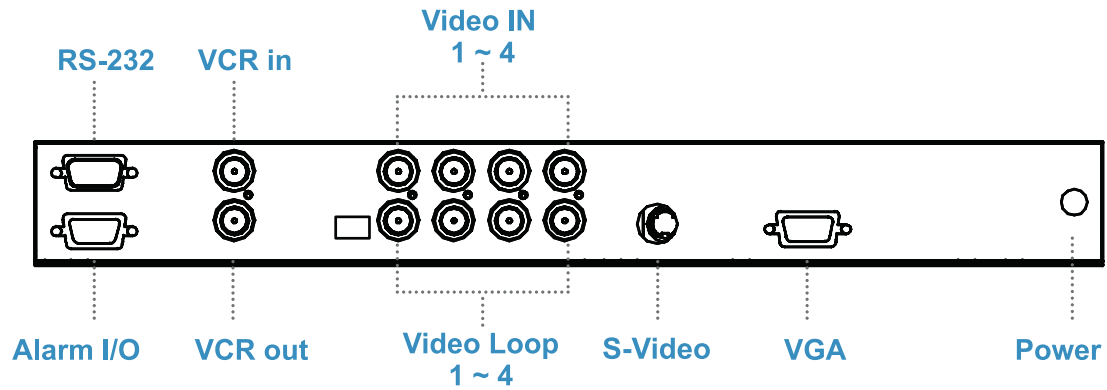

QD Specification

Item		Description	
Model Number		QD (NTSC)	QD (PAL)
Number of Color		16.7 M	16.7 M
Imaging System		NTSC	PAL
Resolution		1024 x 525	1024 x 625
Refresh Rate		60	50
Video Input	Camera Input	1.0 Vpp, 75 Ohm x 4	
	VCR Input	1.0 Vpp, 75 Ohm x 1	
Video Output	Live Monitor	1.0 Vpp, 75 Ohm x 1	
	Loop Through Out	1.0 Vpp, 75 Ohm x 4	
	VCR Output	1.0 Vpp, 75 Ohm x 1	
Auto Gain Control		Yes	
Time / Date		Yes	
On Screen Display		Yes	
Camera Title		8 Character Title	
Display Format	2 x Zoom On Playback	Yes	
	QUAD	Yes	
	FULL	Yes	
	SEQUENCY	Yes	
Dwell Time		0 to 99 Sec Adjustable	
Alarm Inputs		Selectable NO/NC Contacts x 4	
Relay Outputs		NO/NC contacts x 1: 1A @DC24V Max.	
Alarm Hold Time		1 Sec to Non-stop	
Built-in Buzzer		Yes	
Key Lock		Yes	

< 5.9 > Options for Sunlight Readable : Auto Dimming 31.5" FHD Display

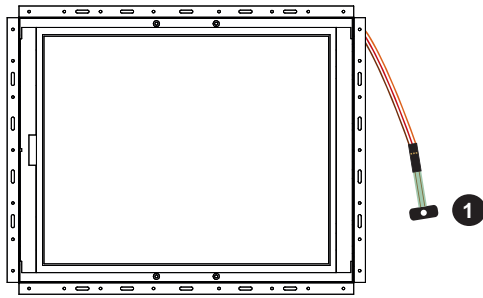

① DA Light sensor on **Pw** model
(66cm from AD board to sensor end)

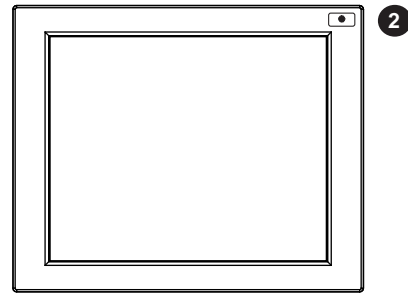

② DA Light sensor on **Aw** model

DA light sensor installed on the display front panel. Users can set auto dimming ON or OFF from OSD menu. Then display brightness changes according to its ambient brightness. Each change causes 10% increase or decrease on display brightness.

Once the auto dimming is ON, users cannot adjust brightness from OSD menu.

Steps : OSD Menu > Picture > Auto Dimming > ON

Light Sensor Operation Range

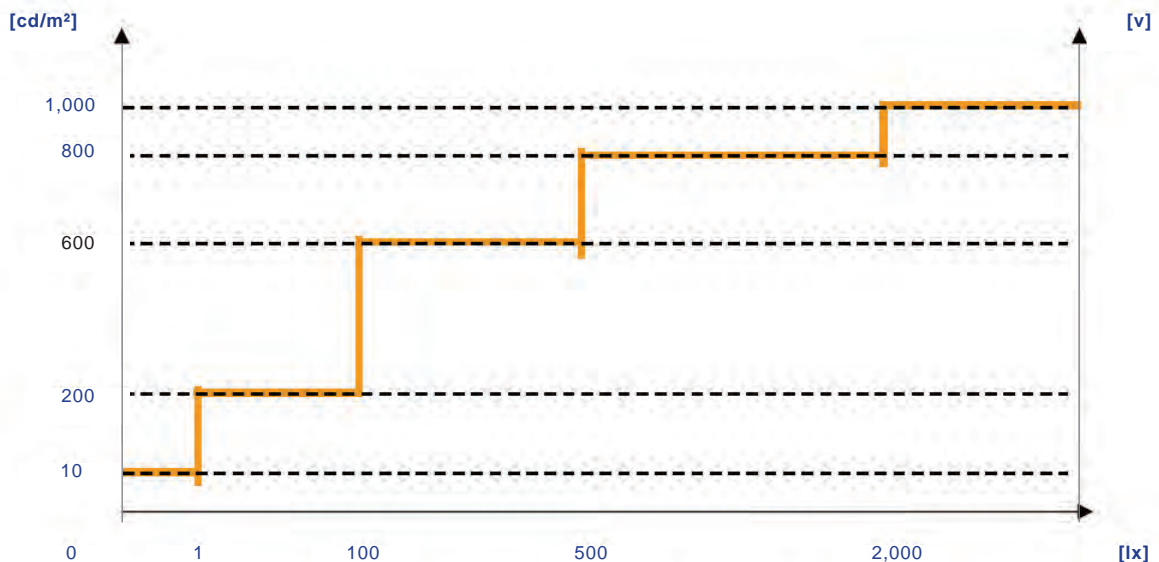

Options : Switch Dimming

DS is a IP54 dimming knob installed on the bottom right side of the front panel. The display can support hyper dimming function to adjust brightness from nearly 0% to 100% via the easy-to-use knob. One click on dimming knob causes 2% increase or decrease on display brightness.

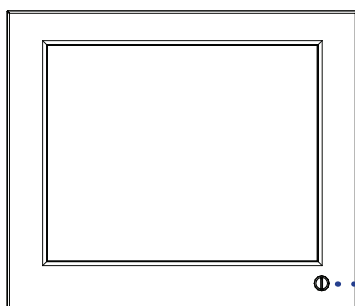

DS dimming knob
Dimensions (W x H) : 15.5 x 14.2 mm

- For this option, front panel and casing dimensions may be changed.
- For HAw series, if DS dimming knob applied, IP protection will be downgraded from IP65 to IP54.

The company reserves the right to modify product specifications without prior notice and assumes no responsibility for any error which may appear in this publication.

All brand names, logo and registered trademarks are properties of their respective owners.

Copyright 2024 Synergy Global Technology Inc. All rights reserved.