

Table of Contents

Chapter 1	Overview	8
1.1	Features.....	8
1.1.1	Highlights.....	9
1.1.2	Technical specifications.....	9
1.2	RAID concepts.....	11
1.2.1	Terminology.....	11
1.2.2	RAID levels.....	13
1.2.3	Volume relationship.....	14
1.3	Storage concepts.....	15
Chapter 2	Installation.....	16
2.1	Package contents.....	16
2.2	The Enclosure Description.....	16
2.3	Make the system connected.....	18
Chapter 3	Quick setup	19
3.1	Management interfaces.....	19
3.1.1	Serial console.....	19
3.1.2	Remote control.....	19
3.1.3	LCM.....	19
3.1.4	Web UI.....	22
3.2	How to use the system quickly.....	24
3.2.1	Quick installation.....	24
3.2.2	Volume creation wizard.....	25
Chapter 4	Configuration	27
4.1	Web UI management interface hierarchy.....	27
4.2	System configuration.....	28
4.2.1	System setting.....	28
4.2.2	IP address.....	29
4.2.3	Login setting.....	29
4.2.4	Mail setting.....	30
4.2.5	Notification setting.....	31
4.3	Volume configuration.....	32
4.3.1	Physical disk.....	32
4.3.2	RAID group.....	36
4.3.3	Virtual disk.....	39
4.3.4	Snapshot.....	43
4.3.5	Logical unit.....	46
4.3.6	Example.....	47
4.4	Enclosure management.....	52
4.4.1	SES configuration.....	52
4.4.2	Hardware monitor.....	52
4.4.3	Hard drive S.M.A.R.T. support.....	54
4.4.4	UPS.....	54
4.5	System maintenance.....	56
4.5.1	System information.....	56
4.5.2	Upgrade.....	57
4.5.3	Reset to factory default.....	57
4.5.4	Import and export.....	58
4.5.5	Event log.....	58

4.5.6	Reboot and shutdown	59
4.6	Logout	59
Chapter 5	Advanced operations	60
5.1	Volume rebuild	60
5.2	RG migration	62
5.3	VD extension	63
5.4	iSnap	64
5.4.1	Create snapshot volume	65
5.4.2	Auto snapshot	66
5.4.3	Rollback	67
5.4.4	iSnap constraint	67
5.5	Disk roaming	69
5.6	VD clone	70
5.7	SAS JBOD expansion	76
5.7.1	Connecting JBOD	76
5.7.2	Upgrade firmware of JBOD	78
Chapter 6	Troubleshooting	79
6.1	System buzzer	79
6.2	Event notifications	79
6.3	How to get support	87
A.	Certification list	89

Chapter 1 Overview

1.1 Features

RS362 16-bay FC RAID Subsystem controller is a high-performance RAID controller.

- Backplane solution
 - **RS362**: FC (x2) -to- SATA II/SAS (xN bays) RAID controller.

RS362 16-bay FC RAID Subsystem controller features:

- Front-end 2-ported 4Gb FC ports with load-balancing & failover for high availability.
- RAID 6, 60 ready.
- Snapshot (iSnap) without relying on host software.
- SATA II drive backward-compatible.
- One logic volume can be shared by as many as 16 hosts.
- Host access control.
- Configurable N-way mirror for high data protection.
- On-line volume migration with no system down-time.
- HDD S.M.A.R.T. enabled for SATA drives.
- SAS JBOD expansion support.
- Microsoft VSS, VDS support.

With proper configuration, controller can provide non-stop service with a high degree of fault tolerance by using **RS362**. RAID technology and advanced array management features. For more details, please contact your direct sales or email to "Sale@RackmountMart.com"

RS362 controller connects to the host system in fibre channel interface. It can be configured to any RAID level. The controller provides reliable data protection for servers and **RAID 6**. The RAID 6 allows two HDD failures without producing any impact on the existing data. Data can be recovered from the existing data and parity drives. (Data can be recovered from the rest of disks/drives.)

Snapshot-on-the-box is a fully usable copy of a defined collection of data that contains an image of the data as it appeared at the point in time, which means a point-in-time data replication. It provides consistent and instant copies of data volumes without any system downtime. Snapshot-on-the-box can keep up to 32 snapshots for one logical volume. Rollback feature is provided for restoring the previous-snapshot data easily while continuously using the volume for further data access. The data access which includes read / write is working as usual without any impact to end users. The "on-the-box" implies that it does not require any proprietary agents installed at host side. The snapshot is taken at target side. It will not consume any host CPU time thus the server is dedicated to the specific or other application.

The snapshot copies can be taken manually or by schedule every hour or every day, depends on the modification.

RS362 controller is the most cost-effective disk array system with completely integrated high-performance and data-protection capabilities which meet or exceed the highest industry standards, and **the best data solution for small / medium business (SMB) users.**

1.1.1 Highlights

- **iStoragePro feature highlights**

1. Front-end 2-ported 4Gb FC ports with load-balancing and failover for high availability
2. RAID 6, 60
3. iSnap without relying on host software
4. SATAII drive support
5. One logic volume can be shared by as many as 16 hosts
6. Host access control
7. Configurable N-way mirror for high data protection
8. On-line volume migration with no system down-time
9. HDD S.M.A.R.T. enabled for SATA drives
10. SAS JBOD expansion support
11. Windows VSS and MPIO enabled
12. Disk auto spindown support

1.1.2 Technical specifications

- **Key components**

1. CPU : Intel Xscale IOP 81341
2. Memory : 1GB ~ 2GB DDRII 533 DIMM supported
3. UARTs : support for serial console management and UPS
4. Fast Ethernet port for web-based management use.
5. Backend : Up to 16 SATA 1.0, 1.5Gb/s or SATA 2.0, 3Gb/s disks supported on the controller board
Backend : Up to 24 SAS 3.0Gb/s, or SATA 1.0, 1.5Gb/s or SATA 2.0, 3Gb/s disks supported on the controller board
6. Front-end : One 4Gb FC controller to have 2 SFP ports
7. LCM supported for easy management use
8. Battery backup support (optional)

- **RAID and volume operation**

1. RAID level: 0,1,0+1,3,5,6,10,30,50, 60 and JBOD
2. Up to 1024 logical volumes in the system

3. Up to 16 PDs can be included in one volume group
4. Global and dedicated hot spare disks
5. Write-through or write-back cache policy for different application usage
6. Multiple RAID volumes support
7. Configurable RAID stripe size
8. Online volume expansion
9. Instant RAID volume availability
10. Auto volume rebuilding
11. Online volume migration

- **Advanced data protection**

1. iSnap utility
 - Writable iSnap volume support
 - Support iStoragePro LVM 3.0 features
2. Up to 16 logical volumes can be configured to have iSnap ability
3. Up to 32 iSnap in one logical volume
4. iSnap rollback mechanism
5. Local N-way mirror
6. On-line disk roaming
7. Smart faulty sector relocation
8. Battery backup support (optional)

- **Enclosure monitoring**

1. S.E.S. support for standard enclosure management
2. UPS management via the specific serial port
3. Fan speed monitoring fan x4
4. Redundant power supply monitor
5. Hardware monitor (Optional)
 - Controllable fan speed monitoring fan x 4
 - Redundant power supply monitor x 2
6. 3.3V, 5V and 12V voltage monitor
7. Thermal sensors x 3 on the controller BOARD (for CPU, backend chip and host channel chip)
Thermal sensors x 3 on the controller BOARD (for CPU, bridge and host channel chip)
8. Thermal sensor x 3 (up to 24) in enclosure.
9. EEPROM for backplane-like HW configuration
10. Status report of the managed SAS/SATA JBODs

- **Management interface**

1. Management UI via serial console, SSH telnet and HTTP Web UI
Management UI via serial console, SSH telnet, HTTP Web UI, and secured Web (HTTPS)
2. Online system firmware upgrade mechanism
3. Event notification via Email, SNMP trap, browser pop-up windows, Syslog, and Windows Messenger.
4. Built-in LCD module to control most enclosure components

- **Host and drive connection**

1. 2 x SFP optical FC host ports support independent access, fail-over or load-balancing
2. 4 x one-by-four connectors for hard drive cabling
3. 32 Multiple target nodes support (multiple aliases)
4. Support Microsoft MPIO hardware provider for load-balancing and failover
5. SCSI-3 compliant
6. Multiple IO transaction processing
7. Tagged command queuing
8. Access control in LUN usage: Read-Write & Read-Only
9. Up to 32 host connection
10. Up to 16 hosts clustered for one volume
11. Hard drive S.M.A.R.T. enabled
12. Compatible with Windows, Linux Operation Systems, Mac, and Solaris
13. Up to 4 SAS JBODs can be connected to one **RS362** by using the SAS JBOD port
14. The overall SAS/SATA drives supported for one controller is up to $16+4*16 = 80$ SAS/SATA drives

- **Chassis integration**

1. Controller form factor
Dimension: 14 cm x 24.9 cm x 3.2 cm (W x D x H)
Dimension: 14.5 cm x 28 cm x 3.2 cm (W x D x H)
2. VHDM-HSD connector to customized backplane, designed with all interfaces mounted on-board exposed to external via customized IO bracket

1.2 RAID concepts

RAID is the abbreviation of “**R**edundant **A**rray of **I**ndependent **D**isks”. The basic idea of RAID is to combine multiple drives together to form one large logical drive. This RAID drive obtains performance, capacity and reliability than a single drive. The operating system detects the RAID drive as a single storage device.

1.2.1 Terminology

The document uses the following terms:

- **Part 1: Common**

RAID	Redundant Array of Independent Disks. There are different RAID levels with different degree of data protection, data availability, and performance to host environment.
-------------	--

PD	The Physical Disk belongs to the member disk of one specific RAID group.
RG	Raid Group . A collection of removable media. One RG consists of a set of VDs and owns one RAID level attribute.
VD	Virtual Disk . Each RD could be divided into several VDs. The VDs from one RG have the same RAID level, but may have different volume capacity.
LUN	Logical Unit Number . A logical unit number (LUN) is a unique identifier which enables it to differentiate among separate devices (each one is a logical unit).
GUI	Graphic User Interface .
RAID cell	When creating a RAID group with a compound RAID level, such as 10, 30, 50 and 60, this field indicates the number of subgroups in the RAID group. For example, 8 disks can be grouped into a RAID group of RAID 10 with 2 cells, 4 cells. In the 2-cell case, PD {0, 1, 2, 3} forms one RAID 1 subgroup and PD {4, 5, 6, 7} forms another RAID 1 subgroup. In the 4-cells, the 4 subgroups are PD {0, 1}, PD {2, 3}, PD {4, 5} and PD {6,7}.
WT	Write-Through cache-write policy. A caching technique in which the completion of a write request is not signaled until data is safely stored in non-volatile media. Each data is synchronized in both data cache and accessed physical disks.
WB	Write-Back cache-write policy. A caching technique in which the completion of a write request is signaled as soon as the data is in cache and actual writing to non-volatile media occurs at a later time. It speeds up system write performance but needs to bear the risk where data may be inconsistent between data cache and the physical disks in one short time interval.
RO	Set the volume to be Read-Only .
DS	Dedicated Spare disks. The spare disks are only used by one specific RG. Others could not use these dedicated spare disks for any rebuilding purpose.
GS	Global Spare disks. GS is shared for rebuilding purpose. If some RGs need to use the global spare disks for rebuilding, they could get the spare disks out from the common spare disks pool for such requirement.

DG	DeGraded mode. Not all of the array's member disks are functioning, but the array is able to respond to application read and write requests to its virtual disks.
SCSI	Small Computer Systems Interface.
SAS	Serial Attached SCSI.
S.M.A.R.T.	Self-Monitoring Analysis and Reporting Technology.
WWN	World Wide Name.
HBA	Host Bus Adapter.
SES	SCSI Enclosure Services.
NIC	Network Interface Card.
BBM	Battery Backup Module

- **Part 2: FC**

FC	Fibre Channel.
MPIO	Multi-Path Input/Output.

1.2.2 RAID levels

There are different RAID levels with different degree of data protection, data availability, and performance to host environment. The description of RAID levels are on the following:

RAID 0	Disk striping. RAID 0 needs at least one hard drive.
RAID 1	Disk mirroring over two disks. RAID 1 needs at least two hard drives.
N-way mirror	Extension to RAID 1 level. It has N copies of the disk.
RAID 3	Striping with parity on the dedicated disk. RAID 3 needs at least three hard drives.
RAID 5	Striping with interspersed parity over the member disks. RAID 3 needs at least three hard drives.

RAID 6	2-dimensional parity protection over the member disks. RAID 6 needs at least four hard drives.
RAID 0+1	Mirroring of the member RAID 0 volumes. RAID 0+1 needs at least four hard drives.
RAID 10	Striping over the member RAID 1 volumes. RAID 10 needs at least four hard drives.
RAID 30	Striping over the member RAID 3 volumes. RAID 30 needs at least six hard drives.
RAID 50	Striping over the member RAID 5 volumes. RAID 50 needs at least six hard drives.
RAID 60	Striping over the member RAID 6 volumes. RAID 60 needs at least eight hard drives.
JBOD	The abbreviation of “ J ust a B unch O f D isks”. JBOD needs at least one hard drive.

1.2.3 Volume relationship

The below graphic is the volume structure. It describes the relationship of RAID components. One RG (RAID group) consists of a set of VDs (Virtual Disk) and owns one RAID level attribute. Each RG can be divided into several VDs. The VDs in one RG share the same RAID level, but may have different volume capacity. All VDs share the CV (Cache Volume) to execute the data transaction. LUN (Logical Unit Number) is a unique identifier, in which users can access through SCSI commands.

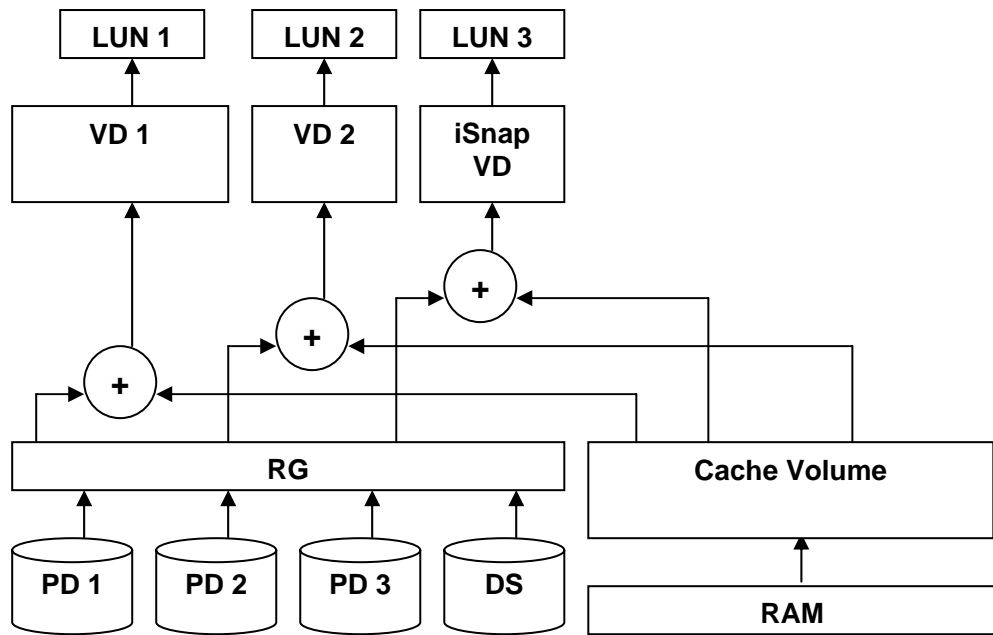

Figure 1.2.3.1

1.3 Storage concepts

Fibre channel started use primarily in the supercomputer field, but has become the standard connection type for storage area networks (SAN) in enterprise storage.

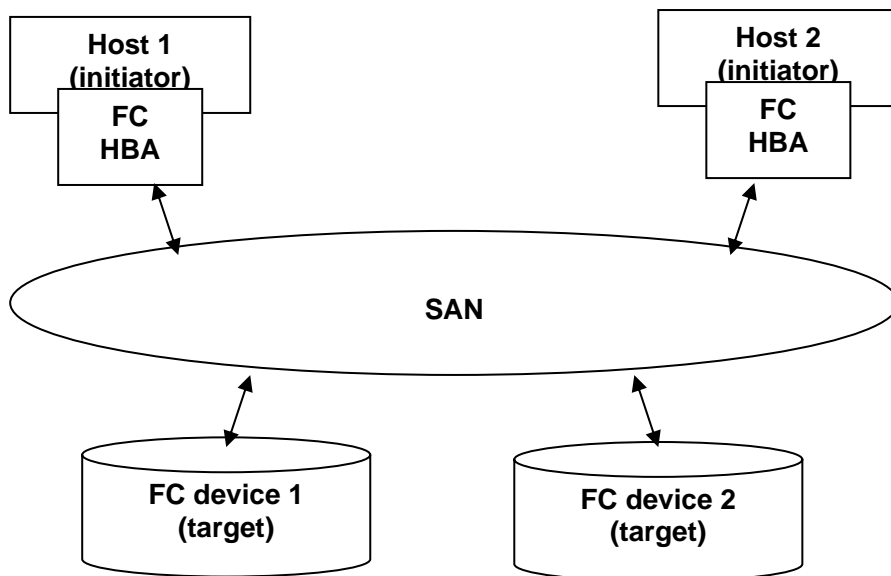

Figure 1.3.1

The target is the storage device itself or an appliance which controls and serves volumes or virtual volumes. The target is the device which performs SCSI commands or bridges to an attached storage device.

Chapter 2 Installation

2.1 Package contents

The package contains the following items:

- One RS362

Contact your supplier if any of the above items are missing or damaged.

The RAM size for are recommended **DDR2-533 1GB** or above. Please refer to the certification list in Appendix A.

2.2 The Enclosure Description

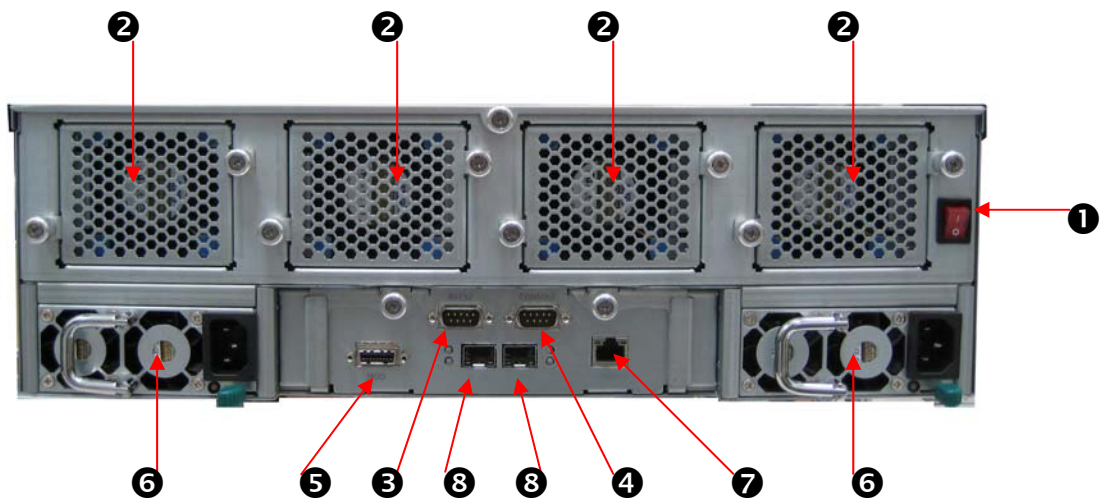

Figure 2.2.1

❶	Power On / Off Switch	: The switch to turn On/ Off the system
❷	Fan 1,2,3,4	: Redundant, hot swappable Fan Modules
❸	RS 232	: For APC UPS
❹	CONSOL (DB9)	: For Web GUI
❺	JBOD	: For cascading iR16SAEJ
❻	PSU-Module	: Redundant, hot swappable power modules

⑦	CONSOLE (RJ45)	: For Web GUI
⑧	FC Port	<p>: Connect transceiver and fiber cable</p> <p>FC LED:</p> <ul style="list-style-type: none"> • Constant bright white → Loss of sync. • Blinking bright white → Fault, 1 blink / sec. • Constant amber → 1G link. • Blinking amber → 1G activity, 4 blinks / sec. • Constant amber → 2G link. • Blinking green → 2G activity, 4 blinks / sec. • Constant blue → 4G link. • Blinking blue → 4G activity, 4 blinks / sec. <p>FC access / fail LED:</p> <ul style="list-style-type: none"> • Yellow → Asserted when FC link is established and packets are being transmitted along with any receive activity. • Red → Asserted when FC link can't establish the link. <p>FC link LED:</p> <ul style="list-style-type: none"> • Yellow + Blue → Asserted when a 1G link is established and maintained. • Yellow → Asserted when a 2G link is established and maintained. • Blue → Asserted when a 4G link is established and maintained.

2.3 Make the system connected

Before starting, prepare the following items.

1. Check “**Certification list**” in Appendix A to confirm the hardware setting is fully supported.
2. Read the latest release note before upgrading. Release note accompanies with its released firmware.
3. A server with a FC HBA.
4. FC cables.
5. CAT 5e, or CAT 6 network cables for management port.
6. Prepare storage system configuration plan.
7. Prepare management port network information. When using static IP, please prepare static IP addresses, subnet mask, and default gateway.
8. Setup the hardware connection before power on servers. Connect console cable, management port cable, and FC cables in advance.
9. Power on and (optional) first, and then power on hosts.

Chapter 3 Quick setup

3.1 Management interfaces

There are three management methods to manage **RS362** controller, describe in the following:

3.1.1 Serial console

Use console cable (NULL modem cable) to connect from console port of **RS362** controller to RS 232 port of management PC. Please refer to figure 2.3.1. The console settings are on the following:

Baud rate: **115200**, 8 data bit, no parity, 1 stop bit, and no flow control.

Terminal type: **vt100**

Login name: **admin**

Default password: **0000**

3.1.2 Remote control

SSH (secure shell) software is required for remote login. The SSH client software is available at the following web site:

SSH Tectia Client: <http://www.ssh.com/>

PuTTY: <http://www.chiark.greenend.org.uk/>

Host name: **192.168.10.50** (Please check the DHCP address first on LCM.)

Login name: **admin**

Default password: **0000**



Tips

iStoragePro controller only supports SSH for remote control. For using SSH, the IP address and password are required for login.

3.1.3 LCM

After booting up the system, the following screen shows management port IP and model name:

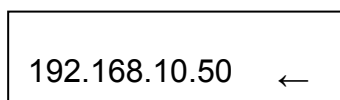

Figure 3.1.3.1

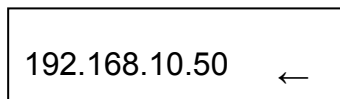

Figure 3.1.3.2

Press “Enter” button, the LCM functions “System Info.”, “Alarm Mute”, “Reset/Shutdown”, “Quick Install”, “Volume Wizard”, “View IP Setting”, “Change IP Config” and “Reset to Default” will rotate by pressing ▲ (up) and ▼ (down).

When there is WARNING event or ERROR event occurred (LCM default filter), the LCM shows the event log to give users more detail from front panel.

The following table is function description of each item.

- **LCM operation description:**

System Info.	Display system information.
Alarm Mute	Mute alarm when error occurs.
Reset/ Shutdown	Reset or shutdown controller.
Quick Install	Quick steps to create a volume. Please refer to next chapter for detailed operation steps in web UI.
Volume Wizard	Smart steps to create a volume. Please refer to next chapter for detailed operation steps in web UI.
View IP Setting	Display current IP address, subnet mask, and gateway.
Change IP config	Set IP address, subnet mask, and gateway. There are 2 options: DHCP (Get IP address from DHCP server) or static IP.
Reset to Default	Reset to default will set password to default: 0000 , and set IP address to default as DHCP setting. Default IP address: 192.168.10.50 (DHCP) Default subnet mask: 255.255.255.0 Default gateway: 192.168.10.254

- LCM menu hierarchy:

Technology ▲▼	[System Info.]	[Firmware Version x.x.x]			
		[RAM Size xxx MB]			
	[Alarm Mute]	[▲Yes No▼]			
	[Reset/Shutdown]	[Reset]	[▲Yes No▼]		
		[Shutdown]	[▲Yes No▼]		
	[Quick Install]	RAID 0 RAID 1 RAID 3 RAID 5 RAID 6 RAID 0+1 xxx GB	[Apply The Config]	[▲Yes No▼]	
	[Volume Wizard]	[Local] RAID 0 RAID 1 RAID 3 RAID 5 RAID 6 RAID 0+1	[Use default algorithm]	[Volume Size] xxx GB	[Apply The Config] [▲Yes No▼]
		[JBOD x] ▲▼ RAID 0 RAID 1 RAID 3 RAID 5 RAID 6 RAID 0+1	[new x disk] ▲▼ xxx GB	Adjust Volume Size	[Apply The Config] [▲Yes No▼]
	[View IP Setting]	[IP Config] [Static IP]			
		[IP Address] [192.168.010.050]			
		[IP Subnet Mask] [255.255.255.0]			
		[IP Gateway] [192.168.010.254]			
	[Change IP Config]	[DHCP]	[▲Yes No▼]		
		[Static IP]	[IP Address]	Adjust IP address	
			[IP Subnet Mask]	Adjust Submask IP	
		[IP Gateway]	Adjust Gateway IP		
		[Apply IP Setting]	[▲Yes No▼]		
[Reset to Default]	[▲Yes No▼]				



Caution

Before power off, it is better to execute “**Shutdown**” to flush the data from cache to physical disks.

3.1.4 Web UI

RS362 controller supports graphic user interface (GUI) to operate. Be sure to connect the LAN cable. The default IP setting is **DHCP**; open the browser and enter:

http://192.168.10.50 (Please check the DHCP address first on LCM.)

And then it will pop up a dialog for authentication.

Figure 3.1.4.1 shows a login dialog box titled "Welcome to iR16FC4ER". The dialog has a light gray background and a red border. It contains the following elements: a "User name" label followed by a text input field containing "admin"; a "Password" label followed by a password input field containing four dots; a language selection dropdown menu currently set to "English"; and a "Login" button.

Figure 3.1.4.1

User name: **admin**

Default password: **0000**

After login, choose the functions which lists on the left side of window to make any configuration.











Figure 3.1.4.2

There are six indicators at the top-right corner for backplane solutions.



Figure 3.1.4.3

• **Indicator description:**

	<p>RAID light:</p> <ul style="list-style-type: none"> • Green → RAID works well. • Red → RAID fails.
	<p>Temperature light:</p> <ul style="list-style-type: none"> • Green → Temperature is normal. • Red → Temperature is abnormal.
	<p>Voltage light:</p> <ul style="list-style-type: none"> • Green → voltage is normal. • Red → voltage is abnormal.
	<p>UPS light:</p> <ul style="list-style-type: none"> • Green → UPS works well. • Red → UPS fails.
	<p>Fan light:</p> <ul style="list-style-type: none"> • Green → Fan works well. • Red → Fan fails.
	<p>Power light:</p> <ul style="list-style-type: none"> • Green → Power works well. • Red → Power fails.
	<p>Return to home page.</p>
	<p>Logout the management web UI.</p>
	<p>Mute alarm beeper.</p>



Tips

If the status indicators in Internet Explorer (IE) are displayed in gray, but not in blinking red, please enable “**Internet Options**” → “**Advanced**” → “**Play animations in webpages**” options in IE. The default value is enabled, but some applications will disable it.

3.2 How to use the system quickly

The following methods will describe the quick guide to use this controller.

3.2.1 Quick installation

It is easy to use “**Quick install**” to create a volume. It uses whole physical disks to create a RG; the system will calculate maximum spaces on RAID levels 0 / 1 / 3 / 5 / 6 / 0+1. “**Quick install**” will occupy all residual RG space for one VD, and it has no space for snapshot and spare. If snapshot is needed, please create volumes by manual, and refer to section 5.4 for more detail. If some physical disks are used in other RGs, “**Quick install**” can not be run because the operation is valid only when all physical disks in this system are free.

Step 1: Click “**Quick install**”, then choose the RAID level. After choosing the RAID level, then click “**Confirm**”. It will link to another page.

/ Quick installation / Step 1

RAID enclosure : Local

RAID level : - RAID 0 (14902 GB) -

- RAID 0 (14902 GB) -
- RAID 1 (1862 GB) -
- RAID 3 (13039 GB) -
- RAID 5 (13039 GB) -
- RAID 6 (11176 GB) -
- RAID 0+1 (7451 GB) -

Figure 3.2.1.1

Step 2: Confirm page. Click “**Confirm**” if all setups are correct. Then a VD will be created.

Step 3: Done. You can start to use the system now.

No.	Name	Size (GB)	Write	Priority	Bg rate	Status	Clone	Schedule	Type	Health	R %	RAID	#LUN	Snapshot space (GB)	#Snapshot	RG name
1	QUICK51979	14902	WB	HI	4	Online	N/A	N/A	RAID	Optimal		RAID 0	1	0/0	0	QUICK53371

Create Configuration

Figure 3.2.1.2

(Figure 3.2.1.2: A virtual disk of RAID 0 is created and is named by system itself.)

3.2.2 Volume creation wizard

“Volume create wizard” has a smarter policy. When the system is inserted with some HDDs. “Volume create wizard” lists all possibilities and sizes in different RAID levels, it will use all available HDDs for RAID level depends on which user chooses. When system has different sizes of HDDs, e.g., 8*200G and 8*80G, it lists all possibilities and combination in different RAID level and different sizes. After user chooses RAID level, user may find that some HDDs are available (free status). It gives user:

1. Biggest capacity of RAID level for user to choose and,
2. The fewest disk number for RAID level / volume size.

E.g., user chooses RAID 5 and the system has 12*200G + 4*80G HDDs inserted. If we use all 16 HDDs for a RAID 5, and then the maximum size of volume is 1200G (80G*15). By the wizard, we do smarter check and find out the most efficient way of using HDDs. The wizard only uses 200G HDDs (Volume size is 200G*11=2200G), the volume size is bigger and fully uses HDD capacity.

Step 1: Select “/ Volume configuration / Volume create wizard” and then choose the RAID level. After the RAID level is chosen, click “Next”. Then it will link to next page.

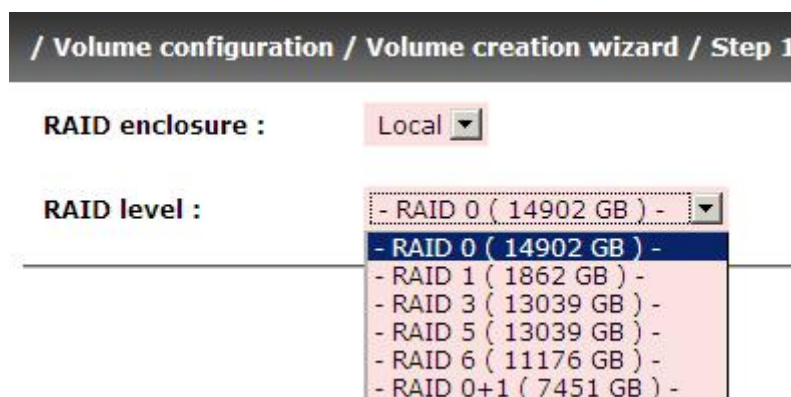

Figure 3.2.2.1

Step 2: Please select the combination of the RG capacity, or “Use default algorithm” for maximum RG capacity. After RG size is chosen, click “Next”.

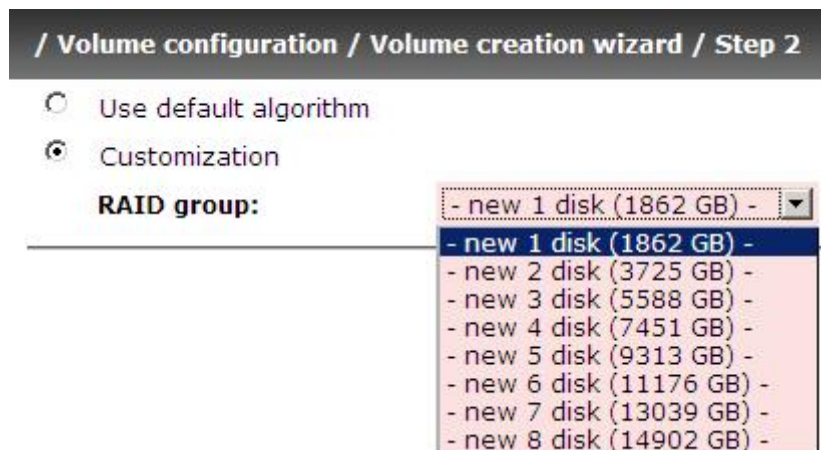

Figure 3.2.2.2

Step 3: Decide VD size. User can enter a number less or equal to the default number. Then click “Next”.



Figure 3.2.2.3

Step 4: Confirm page. Click “Confirm” if all setups are correct. Then a VD will be created.

Step 5: Done. You can start to use the system now.

No.	Name	Size (GB)	Write	Priority	Bg rate	Status	Clone	Schedule	Type	Health	R %	RAID	#LUN	Snapshot space (GB)	#Snapshot	RG name
1	QUICK11520	1862	WB	HI	4	Online	N/A	N/A	RAID	Optimal		RAID 0	1	0/0	0	QUICK98631

Figure 3.2.2.4

(Figure 3.2.2.4: A virtual disk of RAID 0 is created and is named by system itself.)

Chapter 4 Configuration

4.1 Web UI management interface hierarchy

The below table is the hierarchy of web GUI.

Quick installation	→ Step 1 / Step 2 / Confirm
System configuration	
System setting	→ System name / Date and time / System indication
IP address	→ MAC address / Address / DNS / port
Login setting	→ Login configuration / Admin password / User password
Mail setting	→ Mail
Notification setting	→ SNMP / Messenger / System log server / Event log filter
Volume configuration	
Volume create wizard	Step 1 / Step 2 / Step 3 / Step 4 / Confirm
Physical disk	→ Set Free disk / Set Global spare / Set Dedicated spare / Disk Scrub / Upgrade / Turn on/off the indication LED / More information
RAID group	→ Create / Migrate / Move / Activate / Deactivate / Parity check / Delete / Set disk property / More information
Virtual disk	→ Create / Extend / Parity check / Delete / Set property / Attach LUN / Detach LUN / List LUN / Set clone / Clear clone / Start clone / Stop clone / Schedule clone / Set snapshot space / Cleanup snapshot / Take snapshot / Auto snapshot / List snapshot / More information
Snapshot	→ Cleanup / Auto snapshot / Take snapshot / Export / Rollback / Delete
Logical unit	→ Attach / Detach
Enclosure management configuration	
SES	→ Enable / Disable
Hardware monitor	→ Auto shutdown
S.M.A.R.T.	→ S.M.A.R.T. information (Only for SATA disks)
UPS	→ UPS Type / Shutdown battery level / Shutdown delay / Shutdown UPS
Maintenance	
System information	→ System information
Upgrade	→ Browse the firmware to upgrade / Export configuration
Reset to default	→ Sure to reset to factory default?
Import and export	→ Import/Export / Import file
Event log	→ Download / Mute / Clear
Reboot and shutdown	→ Reboot / Shutdown
Logout	Sure to logout?

4.2 System configuration

“System configuration” is designed for setting up the “System setting”, “IP address”, “Login setting”, “Mail setting” and “Notification setting”.

System setting	System name for identification System time for event log
IP address	Internet Protocol(IP) address for remote administration
Login setting	Configuration for auto logout and login lock Administrator's password
Mail setting	Alert by e-mail
Notification setting	Alert via Simple Network Management Protocol(SNMP) Transmits net send and alerter service messages between clients and servers Alert to remote system log server

Figure 4.2.1

4.2.1 System setting

“System setting” can setup system name and date. Default “System name” is composed of model name and serial number of this system.

System name

System name :

Date and time

Change date and time

Current time :

Time zone : ▼

Setup date and time manually

Date : / /

Time : : :

NTP

Server :

Figure 4.2.1.1

Check “Change date and time” to set up the current date, time, and time zone before using or synchronize time from NTP (Network Time Protocol) server. Click “Confirm”.

4.2.2 IP address

MAC address	
MAC address :	00:13:78:AC:03:55

Address	
<input checked="" type="radio"/> DHCP	
<input type="radio"/> BOOTP	
<input type="radio"/> Static	
Address :	192.168.1.106
Mask :	255.255.255.0
Gateway :	192.168.1.1

DNS	
DNS :	205.214.45.10

Port	
HTTP port :	80
HTTPS port :	443
SSH port :	22

Figure 4.2.2.1

“**IP address**” is for changing IP address for remote administration usage. There are two options, DHCP (Get IP address from DHCP server) and static IP. The default setting is DHCP. User can change the HTTP, HTTPS, and SSH port number when the default port number is not allowed on host.

4.2.3 Login setting

“**Login setting**” can set single admin, auto logout time and admin / user password. The single admin is to prevent multiple users access the same system in the same time.

1. **Auto logout:** The options are (1) Disabled; (2) 5 minutes; (3) 30 minutes; (4) 1 hour. The system will log out automatically when user is inactive for a period of time.
2. **Login lock:** Disabled or Enabled. When the login lock is enabled, the system allows only one user to login or modify system settings.

Login configuration	
Auto logout :	- Disabled -
Login lock :	- Disabled -

Admin password	
<input type="checkbox"/> Change admin password	
Old password :	<input type="password"/>
Password :	<input type="password"/>
Confirm :	<input type="password"/>

User password	
<input type="checkbox"/> Change user password	
Password :	<input type="password"/>
Confirm :	<input type="password"/>

Figure 3.2.3.1

Check “**Change admin password**” or “**Change user password**” to change admin or user password. The maximum length of password is 12 characters.

4.2.4 Mail setting

“**Mail setting**” can enter 3 mail addresses for receiving the event notification. Some mail servers would check “**Mail-from address**” and need authentication for anti-spam. Please fill the necessary fields and click “**Send test mail**” to test whether email functions are available. User can also select which levels of event logs are needed to be sent via Mail. Default setting only enables ERROR and WARNING event logs. Please also make sure the DNS server IP is well-setup so the event notification mails can be sent successfully.

Mail	
Mail-from address :	mailman@IR16IS4ER
Mail-to address 1 :	<input type="text"/>
Send events 1 :	<input type="checkbox"/> INFO <input checked="" type="checkbox"/> WARNING <input checked="" type="checkbox"/> ERROR
Mail-to address 2 :	<input type="text"/>
Send events 2 :	<input type="checkbox"/> INFO <input checked="" type="checkbox"/> WARNING <input checked="" type="checkbox"/> ERROR
Mail-to address 3 :	<input type="text"/>
Send events 3 :	<input type="checkbox"/> INFO <input checked="" type="checkbox"/> WARNING <input checked="" type="checkbox"/> ERROR
<input type="checkbox"/> SMTP relay	
SMTP server :	<input type="text"/>
Authentication :	None
Account :	<input type="text"/>
Password :	<input type="password"/>
Confirm :	<input type="password"/>
Send test mail	

Figure 4.2.4.1

4.2.5 Notification setting

“Notification setting” can set up SNMP trap for alerting via SNMP, pop-up message via Windows messenger (not MSN), alert via syslog protocol, and event log filter for web UI and LCM notifications.

SNMP	
SNMP trap address 1 :	<input type="text"/>
SNMP trap address 2 :	<input type="text"/>
SNMP trap address 3 :	<input type="text"/>
Community :	public
MIB file download :	<input type="button" value="download"/>
Send events :	<input type="checkbox"/> INFO <input checked="" type="checkbox"/> WARNING <input checked="" type="checkbox"/> ERROR

Messenger	
Messenger IP/Computer name 1 :	<input type="text"/>
Messenger IP/Computer name 2 :	<input type="text"/>
Messenger IP/Computer name 3 :	<input type="text"/>
Send events :	<input type="checkbox"/> INFO <input checked="" type="checkbox"/> WARNING <input checked="" type="checkbox"/> ERROR

System log server	
Server IP/hostname :	<input type="text"/>
UDP Port :	514
Facility :	User
Event level :	<input type="checkbox"/> INFO <input checked="" type="checkbox"/> WARNING <input checked="" type="checkbox"/> ERROR

Event log filter	
Pop up events :	<input type="checkbox"/> INFO <input type="checkbox"/> WARNING <input type="checkbox"/> ERROR
Show on LCM :	<input type="checkbox"/> INFO <input checked="" type="checkbox"/> WARNING <input checked="" type="checkbox"/> ERROR

Buzzer	
Always disable buzzer :	<input type="checkbox"/>

Figure 4.2.5.1

“SNMP” allows up to 3 SNMP trap addresses. Default community setting is “public”. User can choose the event log levels and default setting enables ERROR and WARNING event log in SNMP. There are many SNMP tools. The following web sites are for your reference:

SNMPC: <http://www.snmpc.com/>

Net-SNMP: <http://net-snmp.sourceforge.net/>

If necessary, click “Download” to get MIB file and import to SNMP.

To use “Messenger”, user must enable the service “Messenger” in Windows (Start → Control Panel → Administrative Tools → Services → Messenger), and then event logs can be received. It allows up to 3 messenger addresses. User can choose the event log levels and default setting enables the WARNING and ERROR event logs.

Using “**System log server**”, user can choose the facility and the event log level. The default port of syslog is 514. The default setting enables event level: INFO, WARNING and ERROR event logs.

There are some syslog server tools. The following web sites are for your reference:
 WinSyslog: <http://www.winsyslog.com/>
 Kiwi Syslog Daemon: <http://www.kiwisyslog.com/>
 Most UNIX systems build in syslog daemon.

“**Event log filter**” setting can enable event level on “Pop up events” and “LCM”.

4.3 Volume configuration

“**Volume configuration**” is designed for setting up the volume configuration which includes “**Volume create wizard**”, “**Physical disk**”, “**RAID group**”, “**Virtual disk**”, “**Snapshot**”, and “**Logical unit**”.

Volume create wizard	Easy and quick step-by-step volume configuration
Physical disk	Hard disks to store data
RAID group	Sets of physical disks with RAID functions
Virtual disk	Slices of RAID groups
Snapshot	Point-in-time copies of the data
Logical unit	Target volumes for hosts access

Figure 4.3.1

4.3.1 Physical disk

“**Physical disk**” can view the status of hard drives in the system. The followings are operational steps:

1. Check the gray button next to the number of slot, it will show the functions which can be executed.
2. Active function can be selected, and inactive functions show up in gray color and cannot be selected.

For example, set PD slot number 11 to dedicated spare disk.

Step 1: Check the gray button of PD 4, select “**Set Dedicated spare**”, it will link to next page.

Slot	Size (GB)	RG name	Status	Health	Usage	Vendor	Serial	Type	Write cache	Standby	Readahead	Command queuing
1	1862	RG-R5	Online	Good	RAID disk	WDC	WD-WMAY00015467	SATA2	Enabled	Disabled	Enabled	Enabled
2	1862	RG-R5	Online	Good	RAID disk	WDC	WD-WMAY00020699	SATA2	Enabled	Disabled	Enabled	Enabled
3	1862	RG-R5	Online	Good	RAID disk	WDC	WD-WMAY00009157	SATA2	Enabled	Disabled	Enabled	Enabled
4	1862		Online	Good	Free disk	WDC	WD-WMAY00016048	SATA2	Enabled	Disabled	Enabled	Enabled
Set Free disk					Free disk	WDC	WD-WMAY00028747	SATA2	Enabled	Disabled	Enabled	Enabled
Set Global spare					Free disk	WDC	WD-WMAY00023955	SATA2	Enabled	Disabled	Enabled	Enabled
Set Dedicated spare					Free disk	WDC	WD-WMAY00021914	SATA2	Enabled	Disabled	Enabled	Enabled
Disk Scrub					Free disk	WDC	WD-WMAY00020730	SATA2	Enabled	Disabled	Enabled	Enabled
Upgrade					Free disk	WDC	WD-WMAY00020730	SATA2	Enabled	Disabled	Enabled	Enabled
Turn on the indication LED					Free disk	WDC	WD-WMAY00020730	SATA2	Enabled	Disabled	Enabled	Enabled
More information					Free disk	WDC	WD-WMAY00020730	SATA2	Enabled	Disabled	Enabled	Enabled

Figure 4.3.1.1

Step 2: If there is any RG which is in protected RAID level and can be set with dedicate spare disk, select one RG, and then click “**Submit**”.

Available RG for slot 4 on Local enclosure :

No.	Name	Total (GB)	Free (GB)	#PD	#VD	Status	Health	RAID	Enclosure
1	RG-R5	3725	3725	3	0	Online	Good	RAID 5	Local

<< Back

Confirm

Figure 4.3.1.2

Step 3: Done. View “**Physical disk**” page.

Slot	Size (GB)	RG name	Status	Health	Usage	Vendor	Serial	Type	Write cache	Standby	Readahead	Command queuing
1	1862	RG-R5	Online	Good	RAID disk	WDC	WD-WMAY00015467	SATA2	Enabled	Disabled	Enabled	Enabled
2	1862	RG-R5	Online	Good	RAID disk	WDC	WD-WMAY00020699	SATA2	Enabled	Disabled	Enabled	Enabled
3	1862	RG-R5	Online	Good	RAID disk	WDC	WD-WMAY00009157	SATA2	Enabled	Disabled	Enabled	Enabled
4	1862	RG-R5	Online	Good	Dedicated spare	WDC	WD-WMAY00016048	SATA2	Enabled	Disabled	Enabled	Enabled
5	1862		Online	Good	Free disk	WDC	WD-WMAY00028747	SATA2	Enabled	Disabled	Enabled	Enabled
6	1862		Online	Good	Free disk	WDC	WD-WMAY00023955	SATA2	Enabled	Disabled	Enabled	Enabled
7	1862		Online	Good	Free disk	WDC	WD-WMAY00021914	SATA2	Enabled	Disabled	Enabled	Enabled
8	1862		Online	Good	Free disk	WDC	WD-WMAY00020730	SATA2	Enabled	Disabled	Enabled	Enabled

Figure 4.3.1.3

(Figure 4.3.1.3: Physical disks in slot 1,2,3 are created for a RG named “RG-R5”. Slot 4 is set as dedicated spare disk of the RG named “RG-R5”. The others are free disks.)

Step 4: The unit of size can be changed from (GB) to (MB). It will display the capacity of hard drive in MB.

Slot	Size (GB) (MB)	RG name	Status	Health	Usage	Vendor	Serial	Type	Write cache	Standby	Readahead	Command queuing
1	1862	RG-R5	Online	Good	RAID disk	WDC	WD-WMAY00020730	SATA2	Enabled	Disabled	Enabled	Enabled
2	1862	RG-R5	Online	Good	RAID disk	WDC	WD-WMAY00020699	SATA2	Enabled	Disabled	Enabled	Enabled
3	1862	RG-R5	Online	Good	RAID disk	WDC	WD-WMAY00009157	SATA2	Enabled	Disabled	Enabled	Enabled
4	1862	RG-R5	Online	Good	Dedicated spare	WDC	WD-WMAY00016048	SATA2	Enabled	Disabled	Enabled	Enabled
5	1862		Online	Good	Free disk	WDC	WD-WMAY00028747	SATA2	Enabled	Disabled	Enabled	Enabled
6	1862		Online	Good	Free disk	WDC	WD-WMAY00023955	SATA2	Enabled	Disabled	Enabled	Enabled
7	1862		Online	Good	Free disk	WDC	WD-WMAY00021914	SATA2	Enabled	Disabled	Enabled	Enabled
8	1862		Online	Good	Free disk	WDC	WD-WMAY00015467	SATA2	Enabled	Disabled	Enabled	Enabled

Figure 4.3.1.4

- **PD column description:**

Slot	The position of a hard drive. The button next to the number of slot shows the functions which can be executed.
Size (GB) (MB)	Capacity of hard drive. The unit can be displayed in GB or MB.
RG Name	RAID group name.
Status	The status of hard drive: <ul style="list-style-type: none"> • “Online” → the hard drive is online. • “Rebuilding” → the hard drive is being rebuilt. • “Transition” → the hard drive is being migrated or is replaced by another disk when rebuilding occurs. • “Scrubbing” → the hard drive is being scrubbed.
Health	The health of hard drive: <ul style="list-style-type: none"> • “Good” → the hard drive is good. • “Failed” → the hard drive is failed. • “Error Alert” → S.M.A.R.T. error alert. • “Read Errors” → the hard drive has unrecoverable read errors.
Usage	The usage of hard drive: <ul style="list-style-type: none"> • “RAID disk” → This hard drive has been set to a RAID group.

	<ul style="list-style-type: none"> • “Free disk” → This hard drive is free for use. • “Dedicated spare” → This hard drive has been set as dedicated spare of a RG. • “Global spare” → This hard drive has been set as global spare of all RGs.
Vendor	Hard drive vendor.
Serial	Hard drive serial number.
Type	Hard drive type: <ul style="list-style-type: none"> • “SATA” → SATA disk. • “SATA2” → SATA II disk. • “SAS” → SAS disk.
Write cache	Hard drive write cache is enabled or disabled. Default is “Enabled” .
Standby	HDD auto spindown to save power. Default is “Disabled” .
Readahead	This feature makes data be loaded to disk’s buffer in advance for further use. Default is “Enabled” .
Command queuing	Newer SATA and most SCSI disks can queue multiple commands and handle one by one. Default is “Enabled” .

- **PD operation description:**

Set Free disk	Make the selected hard drive be free for use.
Set Global spare	Set the selected hard drive to global spare of all RGs.
Set Dedicated spares	Set a hard drive to dedicated spare of the selected RG.
Disk Scrub	Scrub the hard drive.
Upgrade	Upgrade hard drive firmware.
Turn on/off the indication LED	Turn on the indication LED of the hard drive. Click again to turn off.

More information	Show hard drive detail information.
-------------------------	-------------------------------------

4.3.2 RAID group

“RAID group” can view the status of each RAID group. The following is an example to create a RG.

Step 1: Click “Create”, enter “Name”, choose “RAID level”, click “Select PD” to select PD. Then click “Next”. The “Write Cache” option is to enable or disable the write cache option of hard drives. The “Standby” option is to enable or disable the auto spindown function of hard drives, when this option is enabled and hard drives have no I/O access after certain period of time, they will spin down automatically. The “Readahead” option is to enable or disable the read ahead function. The “Command queuing” option is to enable or disable the hard drives’ command queue function.

Name :
RAID level :
RAID PD slot :
Write cache :
Standby :
Readahead :
Command queuing :

Figure 4.3.2.1

Step 2: Confirm page. Click “Confirm” if all setups are correct.

No.	Name	Total [GB]	Free [GB]	#PD	#VD	Status	Health	RAID	Enclosure
1	RG-R0	7451	7451	4	0	Online	Good	RAID 0	Local
2	RG-R5	3725	3725	3	0	Online	Good	RAID 5	Local

Figure 4.3.2.2

(Figure 4.3.2.2: There is a RAID 0 with 4 physical disks, named “RG-R0”. The second RAID group is a RAID 5 with 3 physical disks, named “RG-R5”.) (IR16FC4ER does not have “Enclosure” column.)

Step 3: Done. View “RAID group” page.

- **RG column description:**

No.	RAID group number. The button next to the No. includes the functions which can be executed.
Name	RAID group name.
Total (GB) (MB)	Total capacity of this RAID group. The unit can be displayed in GB or MB.
Free (GB) (MB)	Free capacity of this RAID group. The unit can be displayed in GB or MB.
#PD	The number of physical disks in a RAID group.
#VD	The number of virtual disks in a RAID group.
Status	The status of RAID group: <ul style="list-style-type: none"> • “Online” → the RAID group is online. • “Offline” → the RAID group is offline. • “Rebuild” → the RAID group is being rebuilt. • “Migrate” → the RAID group is being migrated. • “Scrubbing” → the RAID group is being scrubbed.
Health	The health of RAID group: <ul style="list-style-type: none"> • “Good” → the RAID group is good. • “Failed” → the RAID group fails. • “Degraded” → the RAID group is not healthy and not completed. The reason could be lack of disk(s) or have failed disk
RAID	The RAID level of the RAID group.
Enclosure	The enclosure which a RG locates, e.g., in the local enclosure or in the JBOD enclosure.

- **RG operation description:**

Create	Create a RAID group.
Migrate	Change the RAID level of a RAID group. Please refer to next chapter for details.
Move	“Move” the member disks of Raid Group to completely different disks.
Activate	Activate the RAID group after disk roaming; it can be executed when RG status is offline. This is for online disk roaming purpose.
Deactivate	Deactivate the RAID group before disk roaming; it can be executed when RG status is online. This is for online disk roaming purpose.
Parity check	Regenerate parity for the RAID group. It supports RAID 3 / 5 / 6 / 30 / 50 / 60.
Delete	Delete the RAID group.
Set disk property	<p>Change the disk property of write cache and standby options.</p> <p>Write cache:</p> <ul style="list-style-type: none"> • “Enabled” → Enable disk write cache. (Default) • “Disabled” → Disable disk write cache. <p>Standby:</p> <ul style="list-style-type: none"> • “Disabled” → Disable auto spindown. (Default) • “30 sec / 1 min / 5 min / 30 min” → Enable hard drive auto spindown to save power when no access after certain period of time. <p>Read ahead:</p> <ul style="list-style-type: none"> • “Enabled” → Enable disk read ahead. (Default) • “Disabled” → Disable disk read ahead. <p>Command queuing:</p> <ul style="list-style-type: none"> • “Enabled” → Enable disk command queue. (Default) • “Disabled” → Disable disk command queue.
More information	Show RAID group detail information.

4.3.3 Virtual disk

“Virtual disk” can view the status of each Virtual disk, create, and modify virtual disks. The following is an example to create a VD.

Step 1: Click “Create”, enter “Name”, select RAID group from “RG name”, enter required “Capacity (GB)/(MB)”, change “Stripe height (KB)”, change “Block size (B)”, change “Read/Write” mode, set virtual disk “Priority”, select “Bg rate” (Background task priority), and change “Readahead” option if necessary. “Erase” option will wipe out old data in VD to prevent that OS recognizes the old partition. There are three options in “Erase”: None (default), erase first 1GB or full disk. Last, select “Type” mode for normal or clone usage. Then click “Confirm”.

Name :	VD-01
RG name :	RG-R0
Capacity :	30 GB
Stripe height (KB) :	64
Block size (B) :	512
Read/Write :	<input type="radio"/> Write-through cache <input checked="" type="radio"/> Write-back cache
Priority :	<input checked="" type="radio"/> High priority <input type="radio"/> Middle priority <input type="radio"/> Low priority
Bg rate :	4
Readahead :	Enabled
Erase :	None
Type :	RAID

Figure 4.3.3.1



Caution

If shutdown or reboot the system when creating VD, the erase process will stop.

Step 2: Confirm page. Click “Confirm” if all setups are correct.

No.	Name	Size (GB)	Write	Priority	Bg rate	Status	Clone	Schedule	Type	Health	R %	RAID	#LUN	Snapshot space (GB)	#Snapshot	RG name
1	VD-01	30	WB	HI	4	Online	N/A	N/A	RAID	Optimal		RAID 0	0	0/0	0	RG-R0
2	VD-02	20	WB	HI	4	Initiating	N/A	N/A	RAID	Optimal	42	RAID 5	0	0/0	0	RG-R5

Extend
 Parity check
 Delete
 Set property
 Attach LUN
 Detach LUN
 List LUN
 Set done
 Set snapshot space
 Cleanup snapshot
 Take snapshot
 Auto snapshot
 List snapshot
 More information

Figure 4.3.3.2

(Figure 4.3.3.2: Create a VD named “VD-01”, from “RG-R0”. The second VD is named “VD-02”, it’s initializing.)

Step 3: Done. View “Virtual disk” page.

- **VD column description:**

No.	Virtual disk number. The button includes the functions which can be executed.
Name	Virtual disk name.
Size (GB) (MB)	Total capacity of the virtual disk. The unit can be displayed in GB or MB.
Write	The right of virtual disk: <ul style="list-style-type: none"> • “WT” → Write Through. • “WB” → Write Back. • “RO” → Read Only.
Priority	The priority of virtual disk: <ul style="list-style-type: none"> • “HI” → High priority. • “MD” → MiDdle priority. • “LO” → LOw priority.

Bg rate	Background task priority: <ul style="list-style-type: none"> • “4 / 3 / 2 / 1 / 0” → Default value is 4. The higher number the background priority of a VD is, the more background I/O will be scheduled to execute.
Status	The status of virtual disk: <ul style="list-style-type: none"> • “Online” → The virtual disk is online. • “Offline” → The virtual disk is offline. • “Initiating” → The virtual disk is being initialized. • “Rebuild” → The virtual disk is being rebuilt. • “Migrate” → The virtual disk is being migrated. • “Rollback” → The virtual disk is being rolled back. • “Parity checking” → The virtual disk is being parity check.
Clone	The target name of virtual disk.
Schedule	The clone schedule of virtual disk:
Type	The type of virtual disk: <ul style="list-style-type: none"> • “RAID” → the virtual disk is normal. • “BACKUP” → the virtual disk is for clone usage.
Health	The health of virtual disk: <ul style="list-style-type: none"> • “Optimal” → the virtual disk is working well and there is no failed disk in the RG. • “Degraded” → At least one disk from the RG of the Virtual disk is failed or plugged out. • “Failed” → the RAID group disk of the VD has single or multiple failed disks than its RAID level can recover from data loss. • “Partially optimal” → the virtual disk has experienced recoverable read errors. After passing parity check, the health will become “Optimal”.
R %	Ratio (%) of initializing or rebuilding.
RAID	RAID level.
#LUN	Number of LUN(s) that virtual disk is attached to.
Snapshot	The virtual disk size that is used for snapshot. The number means “ Used snapshot space ” / “ Total snapshot ”

(GB) (MB)	space ". The unit can be displayed in GB or MB.
#Snapshot	Number of snapshot(s) that have been taken.
RG name	The RG name of the virtual disk

- **VD operation description:**

Create	Create a virtual disk.
Extend	Extend the virtual disk capacity.
Parity check	Execute parity check for the virtual disk. It supports RAID 3 / 5 / 6 / 30 / 50 / 60. Regenerate parity: <ul style="list-style-type: none"> • "Yes" → Regenerate RAID parity and write. • "No" → Execute parity check only and find mismatches. It will stop checking when mismatches count to 1 / 10 / 20 / ... / 100.
Delete	Delete the virtual disk.
Set property	Change the VD name, right, priority, bg rate and read ahead. Right: <ul style="list-style-type: none"> • "WT" → Write Through. • "WB" → Write Back. (Default) • "RO" → Read Only. Priority: <ul style="list-style-type: none"> • "HI" → High priority. (Default) • "MD" → MiDdle priority. • "LO" → LOw priority. Bg rate: <ul style="list-style-type: none"> • "4 / 3 / 2 / 1 / 0" → Default value is 4. The higher number the background priority of a VD is, the more background I/O will be scheduled to execute. Read ahead: <ul style="list-style-type: none"> • "Enabled" → Enable disk read ahead. (Default) • "Disabled" → Disable disk read ahead. Type:

	<ul style="list-style-type: none"> • “RAID” → the virtual disk is normal. (Default) • “Backup” → the virtual disk is for clone usage.
Attach LUN	Attach to a LUN.
Detach LUN	Detach to a LUN.
List LUN	List attached LUN(s).
Set clone	Set the target virtual disk for clone.
Clear clone	Clear clone function.
Start clone	Start clone function.
Stop clone	Stop clone function.
Schedule clone	Set clone function by schedule.
Set snapshot space	Set snapshot space for taking snapshot. Please refer to next chapter for more detail.
Cleanup snapshot	Clean all snapshots of a VD and release the snapshot space.
Take snapshot	Take a snapshot on the virtual disk.
Auto snapshot	Set auto snapshot on the virtual disk.
List snapshot	List all snapshots of the virtual disk.
More information	Show virtual disk detail information.

4.3.4 Snapshot

“Snapshot” can view the status of snapshot, create, and modify snapshots. Please refer to next chapter for more detail about snapshot concept. The following is an example to take a snapshot.

Step 1: Create snapshot space. In **“/ Volume configuration / Virtual disk”**, check the gray button next to the VD number; click **“Set snapshot space”**.

Step 2: Set snapshot space. Then click **“Confirm”**. The snapshot space is created.

/ Volume configuration / Virtual disk / Set snapshot space

Size : 15 GB
 Available: 5558 GB / Minimum: 4 GB
 Free : 5558 GB

Figure 4.3.4.1

No.	Name	Size (GB)	Write	Priority	Bg rate	Status	Clone	Schedule	Type	Health	R %	RAID	#LUN	Snapshot space (GB)	#Snapshot	RG name
1	VD-01	30	WB	HI	4	Online	N/A	N/A	RAID	Optimal		RAID 0	0	3/15	0	RG-R0
2	VD-02	20	WB	HI	4	Online	N/A	N/A	RAID	Optimal		RAID 5	0	0/0	0	RG-R5

Figure 4.3.4.2

(Figure 4.3.4.2: “VD-01” snapshot space has been created, snapshot space is 15GB, and used 3GB for saving snapshot index.)

Step 3: Take a snapshot. In “/ Volume configuration / Snapshot”, click “Take snapshot”. It will link to next page. Enter a snapshot name.

Linked snapshot for VD: - VD-01 -

No.	Name	Used (GB)	Status	Health	Exposure	Right	#LUN	Created time
1	SnapVD-01	0	N/A	Good	No	N/A	N/A	Wed Dec 1 06:07:45 2010

Expose
 Rollback
 Delete

<< Back Cleanup Auto snapshot Take snapshot

Figure 4.3.4.3

Step 4: Expose the snapshot VD. Check the gray button next to the Snapshot VD number; click “Expose”. Enter a capacity for snapshot VD. If size is zero, the exposed snapshot VD will be read only. Otherwise, the exposed snapshot VD can be read / written, and the size will be the maximum capacity to read / write. IR16FC4ER supports read-only, and IR16FC4ER supports writable snapshot.

/ Volume configuration / Snapshot / Set quota

Size : 11 GB
 Available : 11 GB

Figure 4.3.4.4

Linked snapshot for VD: - VD-01 -

No.	Name	Used (GB)	Status	Health	Exposure	Right	#LUN	Created time
1	SnapVD-01	0	N/A	Good	Yes	Read-only	0	Wed Dec 8 16:46:43 2010
2	SnapVD-02	0	N/A	Good	Yes	Read-write	0	Wed Dec 8 16:47:20 2010

Unexpose
 Rollback
 Delete
 Attach
 Detach
 List LUN

<< Back
Cleanup
Auto snapshot
Take snapshot

Figure 4.3.4.5

(Figure 4.3.4.5: This is the snapshot list of “VD-01”. There are two snapshots. Snapshot VD “SnapVD-01” is exposed as read-only, “SnapVD-02” is exposed as read-write.)

Step 5: Attach a LUN to a snapshot VD. Please refer to the next section for attaching a LUN.

Step 6: Done. Snapshot VD can be used.

- **Snapshot column description:**

No.	The number of this snapshot VD. The button next to the snapshot VD No. includes the functions which can be executed.
Name	Snapshot VD name.
Used (GB) (MB)	The amount of snapshot space that has been used. The unit can be displayed in GB or MB.
Status	The status of snapshot: <ul style="list-style-type: none"> • “N/A” → The snapshot is normal. • “Replicated” → The snapshot is for clone. • “Abort” → The snapshot is over space and abort.
Health	The health of snapshot: <ul style="list-style-type: none"> • “Good” → The snapshot is good. • “Failed” → The snapshot fails.
Exposure	Snapshot VD is exposed or not.
Right	The right of snapshot:

	<ul style="list-style-type: none"> • “Read-write” → The snapshot VD can be read / write. • “Read-only” → The snapshot VD is read only.
#LUN	Number of LUN(s) that snapshot VD is attached.
Created time	Snapshot VD created time.

- **Snapshot operation description:**

Expose/Unexpose	Expose / unexpose the snapshot VD.
Rollback	Rollback the snapshot VD.
Delete	Delete the snapshot VD.
Attach	Attach a LUN.
Detach	Detach a LUN.
List LUN	List attached LUN(s).

4.3.5 Logical unit

“**Logical unit**” can view, create, and modify the status of attached logical unit number of each VD.

User can attach LUN by clicking the “**Attach**”. “**Host**” must enter with a FC node name for access control, or fill-in wildcard “*”, which means every host can access the volume. Choose LUN number and permission, and then click “**Confirm**”.

VD : VD-01 (30GB) ▾

Host (iSCSI node name) : *

Target (iSCSI node name) : all

LUN : - 1 - ▾

Permission :
 Read-only Read-write

Figure 4.3.5.1

Host	Target	LUN	Permission	VD name
*	2000001378AC00E5	0	Read-write	VD-01
2001001378AC00E5	2000001378AC00E5	1	Read-write	VD-02

Figure 4.3.5.2

(Figure 4.3.5.2: VD-01 is attached to LUN 0 and every host can access. VD-02 is attached to LUN 1 and only the FC node name is named “2001001378AC00E5” can access.)

- **LUN operation description:**

Attach	Attach a logical unit number to a virtual disk.
Detach	Detach a logical unit number from a virtual disk.

The matching rules of access control are followed from the LUNs’ created time; the earlier created LUN is prior to the matching rules. For example: there are 2 LUN rules for the same UDV, one is “*”, LUN 0; the other is “FC node name1”, LUN 1. The other host “FC node name2” can login successfully because it matches the rule 1.

4.3.6 Example

The following is an example to create volumes. This example is to create two VDs and set a global spare disk.

- **Example**

This example is to create two VDs in one RG, each VD shares the cache volume. The cache volume is created after system boots up automatically. Then set a global spare disk. Last, delete all of them.

Step 1: Create a RG (RAID group).

To create a RAID group, please follow the procedures:

Name : RG-R5
 RAID level : RAID 5
 RAID PD slot : 1 2 3 Select PD
 Write cache : Enabled
 Standby : Disabled
 Readahead : Enabled
 Command queuing : Enabled

<< Back Next >>

Figure 4.3.6.1

1. Select “/ Volume configuration / RAID group”.
2. Click “Create”.
3. Input a RG Name, choose a RAID level from the list, click “Select PD” to choose the RAID physical disks, then click “Next”.
4. Check the setting. Click “Confirm” if all setups are correct.
5. Done. A RG has been created.

No.	Name	Total (GB)	Free (GB)	#PD	#VD	Status	Health	RAID	Enclosure
1	RG-R5	3725	3725	3	0	Online	Good	RAID 5	Local

Figure 4.3.6.2

(Figure 4.3.6.2: Creating a RAID 5 with 3 physical disks, named “RG-R5”).

Step 2: Create VD (Virtual Disk).

To create a data user volume, please follow the procedures.

Name : VD-R5-1
 RG name : RG-R5
 Capacity : 50 GB
 Stripe height (KB) : 64
 Block size (B) : 512
 Read/Write : Write-through cache Write-back cache
 Priority : High priority Middle priority Low priority
 Bg rate : 4
 Readahead : Enabled
 Erase : None
 Type : RAID

<< Back Confirm

Figure 4.3.6.3

1. Select “/ Volume configuration / Virtual disk”.
2. Click “Create”.
3. Input a VD name, choose a RG Name and enter a size for this VD; decide the stripe height, block size, read / write mode, bg rate, and set priority, finally click “Confirm”.

4. Done. A VD has been created.
5. Follow the above steps to create another VD.

No.	Name	Size (GB)	Write	Priority	Bg rate	Status	Clone	Schedule	Type	Health	R %	RAID	#LUN	Snapshot space (GB)	#Snapshot	RG name
1	VD-R5-1	50	WB	HI	4	Initiating	N/A	N/A	RAID	Optimal	18	RAID 5	0	0/0	0	RG-R5
2	VD-R5-2	64	WB	HI	4	Initiating	N/A	N/A	RAID	Optimal	0	RAID 5	0	0/0	0	RG-R5

Figure 4.3.6.4

(Figure 4.3.6.4: Creating VDs named “VD-R5-1” and “VD-R5-2” from RAID group “RG-R5”, the size of “VD-R5-1” is 50GB, and the size of “VD-R5-2” is 64GB. There is no LUN attached.)

Step 3: Attach a LUN to a VD.

There are 2 methods to attach a LUN to a VD.

1. In “/ Volume configuration / Virtual disk”, check the gray button next to the VD number; click “Attach LUN”.
2. In “/ Volume configuration / Logical unit”, click “Attach”.

The procedures are as follows:

VD :

Host (FC node name) :

Target (FC node name) :

LUN :

Permission : Read-only Read-write

Figure 4.3.6.5

1. Select a VD.
2. Input “Host” name, which is a FC node name for access control, or fill-in wildcard “*”, which means every host can access to this volume. Choose LUN and permission, and then click “Confirm”.
3. Done.

Host	Target	LUN	Permission	VD name
*	2000001378AC00E5	0	Read-write	VD-R5-1
2006001378AC00E5	2000001378AC00E5	1	Read-write	VD-R5-2

Figure 4.3.6.6

(Figure 4.3.6.6: VD-R5-1 is attached to LUN 0. VD-R5-2 is attached to LUN 1.)



Tips

The matching rules of access control are from the LUNs' created time, the earlier created LUN is prior to the matching rules.

Step 4: Set a global spare disk.

To set a global spare disk, please follow the procedures.

1. Select “/ Volume configuration / Physical disk”.
2. Check the gray button next to the PD slot; click “Set global space”.
3. “Global spare” status is shown in “Usage” column.

Slot	Size {GB}	RG name	Status	Health	Usage	Vendor	Serial	Type	Write cache	Standby	Readahead	Command queuing
1	1862	RG-R5	Online	Good	RAID disk	WDC	WD-WMAY00015467	SATA2	Enabled	Disabled	Enabled	Enabled
2	1862	RG-R5	Online	Good	RAID disk	WDC	WD-WMAY00020699	SATA2	Enabled	Disabled	Enabled	Enabled
3	1862	RG-R5	Online	Good	RAID disk	WDC	WD-WMAY00009157	SATA2	Enabled	Disabled	Enabled	Enabled
4	1862		Online	Good	Global spare	WDC	WD-WMAY00016048	SATA2	Enabled	Disabled	Enabled	Enabled
				Good	Free disk	WDC	WD-WMAY00028747	SATA2	Enabled	Disabled	Enabled	Enabled
				Good	Free disk	WDC	WD-WMAY00023955	SATA2	Enabled	Disabled	Enabled	Enabled
				Good	Free disk	WDC	WD-WMAY00021914	SATA2	Enabled	Disabled	Enabled	Enabled
				Good	Free disk	WDC	WD-WMAY00020730	SATA2	Enabled	Disabled	Enabled	Enabled

Figure 4.3.6.7

(Figure 4.3.6.7: Slot 4 is set as a global spare disk.)

Step 5: Done.

Delete VDs, RG, please follow the below steps.

Step 6: Detach a LUN from the VD.

In “/ Volume configuration / Logical unit”,

Host	Target	LUN	Permission	VD name
∞	2000001378AC00E5	0	Read-write	VD-R5-1
20060	2000001378AC00E5	1	Read-write	VD-R5-2

Figure 4.3.6.8

1. Check the gray button next to the LUN; click “Detach”. There will pop up a confirmation page.

2. Choose “**OK**”.
3. Done.

Step 7: Delete a VD (Virtual Disk).

To delete the virtual disk, please follow the procedures:

1. Select “/ **Volume configuration / Virtual disk**”.
2. Check the gray button next to the VD number; click “**Delete**”. There will pop up a confirmation page, click “**OK**”.
3. Done. Then, the VD is deleted.



Tips

When deleting VD directly, the attached LUN(s) of to this VD will be detached together.

Step 8: Delete a RG (RAID group).

To delete a RAID group, please follow the procedures:

1. Select “/ **Volume configuration / RAID group**”.
2. Select a RG which all its VD are deleted, otherwise the this RG cannot be deleted.
3. Check the gray button next to the RG number click “**Delete**”.
4. There will pop up a confirmation page, click “**OK**”.
5. Done. The RG has been deleted.



Tips

The action of deleting one RG will succeed only when all of the related VD(s) are deleted in this RG. Otherwise, user cannot delete this RG.

Step 9: Free a global spare disk.

To free a global spare disk, please follow the procedures.

1. Select “/ **Volume configuration / Physical disk**”.
2. Check the gray button next to the PD slot; click “**Set Free disk**”.

Step 10: Done, all volumes have been deleted.

4.4 Enclosure management

“Enclosure management” allows managing enclosure information including “**SES configuration**”, “**Hardware monitor**”, “**S.M.A.R.T.**” and “**UPS**”. For the enclosure management, there are many sensors for different purposes, such as temperature sensors, voltage sensors, hard disk status, fan sensors, power sensors, and LED status. Due to the different hardware characteristics among these sensors, they have different polling intervals. Below are the details of the polling time intervals:

1. Temperature sensors: 1 minute.
2. Voltage sensors: 1 minute.
3. Hard disk sensors: 10 minutes.
4. Fan sensors: 10 seconds . When there are 3 errors consecutively, system sends ERROR event log.
5. Power sensors: 10 seconds, when there are 3 errors consecutively, system sends ERROR event log.
6. LED status: 10 seconds.

SES configuration	Access control for SES management
Hardware monitor	System monitored voltage, temperature and battery backup module
S.M.A.R.T.	Self-monitoring analysis and reporting technology for physical disks
UPS	Uninterruptible power supply

Figure 4.4.1

4.4.1 SES configuration

SES represents **SCSI Enclosure Services**, one of the enclosure management standards. “**SES configuration**” can enable or disable the management of SES.

Host	Target	LUN
*	2001001378AC00E5	0

Figure 4.4.1.1

(Figure 4.4.1.1: Enable SES in LUN 0, and can be accessed from every host)

The SES client software is available at the following web site:

SANtools: <http://www.santools.com/>

4.4.2 Hardware monitor

“**Hardware monitor**” can view the information of current voltages and temperatures.

Local

Temperature : (C) (F)

Type	Item	Value	Status
Voltage	Onboard +1.2V	+1.22 V (min = +1.08 V, max = +1.32 V)	OK
	Onboard +3.3V	+3.38 V (min = +3.04 V, max = +3.56 V)	OK
	Onboard +5V	+5.02 V (min = +4.60 V, max = +5.40 V)	OK
	Onboard +12V	+12.08 V (min = +11.04 V, max = +12.96 V)	OK
	Onboard +1.8V	+1.84 V (min = +1.62 V, max = +1.98 V)	OK
	PSU +5V(C60)	+5.02 V (min = +4.60 V, max = +5.40 V)	OK
	PSU +12V(C60)	+12.23 V (min = +11.04 V, max = +12.96 V)	OK
	PSU +3.3V(C60)	+3.39 V (min = +3.04 V, max = +3.56 V)	OK
Temperature	Core Processor	+48.5 (C) (hyst = +0.0 (C), high = +80.0 (C))	OK
	Onboard SAS Device 1	+47.0 (C) (hyst = +0.0 (C), high = +80.0 (C))	OK
	Onboard SAS Device 2	+43.0 (C) (hyst = +0.0 (C), high = +80.0 (C))	OK
	Location 01(C60)	+23.0 (C) (hyst = +5.0 (C), high = +55.0 (C))	OK
	Location 02(C60)	+25.0 (C) (hyst = +5.0 (C), high = +55.0 (C))	OK
	Location 03(C60)	+25.5 (C) (hyst = +5.0 (C), high = +55.0 (C))	OK
	Location 04(C60)	+28.0 (C) (hyst = +5.0 (C), high = +55.0 (C))	OK
	Location 05(C60)	+29.0 (C) (hyst = +5.0 (C), high = +55.0 (C))	OK
	Location 06(C60)	+28.5 (C) (hyst = +5.0 (C), high = +55.0 (C))	OK
Location 07(C60)	+29.0 (C) (hyst = +5.0 (C), high = +55.0 (C))	OK	
Location 08(C60)	+30.5 (C) (hyst = +5.0 (C), high = +55.0 (C))	OK	
Power Supply	PSU1(C60)	N/A	OK
	PSU2(C60)	N/A	OK
Cooling	FAN1(C60)	4963 RPM	OK
	FAN2(C60)	4963 RPM	OK
	FAN3(C60)	5113 RPM	OK
	FAN4(C60)	4963 RPM	OK

Figure 4.4.2.1

If “Auto shutdown” is checked, the system will shutdown automatically when voltage or temperature is out of the normal range. For better data protection, please check “Auto Shutdown”.

For better protection and avoiding single short period of high temperature triggering auto shutdown, the system use multiple condition judgments to trigger auto shutdown, below are the details of when the Auto shutdown will be triggered.

1. There are several sensors placed on systems for temperature checking. System will check each sensor for every 30 seconds. When one of these sensor is over high temperature threshold for continuous 3 minutes, auto shutdown will be triggered immediately.
2. The core processor temperature limit is 80°C . The on board SAS device temperature limit is 80°C . The backplane board temperature limit is 58°C .
3. If the high temperature situation doesn't last for 3 minutes, system will not trigger auto shutdown.

4.4.3 Hard drive S.M.A.R.T. support

S.M.A.R.T. (Self-Monitoring Analysis and Reporting Technology) is a diagnostic tool for hard drives to deliver warning of drive failures in advance. S.M.A.R.T. provides users chances to take actions before possible drive failure.

S.M.A.R.T. measures many attributes of the hard drive all the time and inspects the properties of hard drives which are close to be out of tolerance. The advanced notice of possible hard drive failure can allow users to back up hard drive or replace the hard drive. This is much better than hard drive crash when it is writing data or rebuilding a failed hard drive.

“**S.M.A.R.T.**” can display S.M.A.R.T. information of hard drives. The number is the current value; the number in parenthesis is the threshold value. The threshold values from different hard drive vendors are different; please refer to hard drive vendors’ specification for details.

S.M.A.R.T. only supports SATA drives. SAS drives do not have this function now. It will show N/A in the web page for SAS drives.

Slot	HDD type	Read error rate	Spin up time	Reallocated sector count	Seek error rate	Spin up retries	Calibration retries	Temperature
1	SATA2	200(51)	168(21)	199(140)	200(0)	100(0)	100(0)	27
2	SATA2	200(51)	165(21)	200(140)	200(0)	100(0)	100(0)	27
3	SATA2	200(51)	168(21)	200(140)	200(0)	100(0)	100(0)	28
4	SATA2	200(51)	164(21)	200(140)	200(0)	100(0)	100(0)	26
5	SATA2	200(51)	166(21)	200(140)	200(0)	100(0)	100(0)	26
6	SATA2	200(51)	169(21)	200(140)	200(0)	100(0)	100(0)	26
7	SATA2	200(51)	172(21)	200(140)	200(0)	100(0)	100(0)	27
8	SATA2	200(51)	161(21)	200(140)	200(0)	100(0)	100(0)	26

Figure 4.4.3.1

4.4.4 UPS

“**UPS**” can set up UPS (Uninterruptible Power Supply).

UPS type :

Shutdown battery level (%) :

Shutdown delay (s) :

Shutdown UPS :

Status :

Battery level :

Figure 4.4.4.1

(Figure 4.5.4.1: Without UPS.)

Currently, the system only supports and communicates with smart-UPS of APC (American Power Conversion Corp.) UPS. Please review the details from the website: <http://www.apc.com/>.

First, connect the system and APC UPS via RS-232 for communication. Then set up the shutdown values (shutdown battery level %) when power is failed. UPS in other companies can work well, but they have no such communication feature with the system.

The screenshot shows a configuration interface for a Smart-UPS. It includes the following elements:

- UPS type :** A dropdown menu set to "Smart-UPS".
- Shutdown battery level (%) :** A dropdown menu set to "5".
- Shutdown delay (s) :** A dropdown menu set to "30".
- Shutdown UPS :** A dropdown menu set to "ON".
- Status :** A text field that is currently empty.
- Battery level :** A progress bar showing 0% battery level.
- Confirm :** A button located at the bottom right of the window.

Figure 4.4.4.2

(Figure 4.4.4.2: With Smart-UPS.)

- **UPS column description:**

UPS Type	Select UPS Type. Choose Smart-UPS for APC, None for other vendors or no UPS.
Shutdown Battery Level (%)	When below the setting level, system will shutdown. Setting level to "0" will disable UPS.
Shutdown Delay (s)	If power failure occurs, and system power can not recover, the system will shutdown. Setting delay to "0" will disable the function.
Shutdown UPS	Select ON, when power is gone, UPS will shutdown by itself after the system shutdown successfully. After power comes back, UPS will start working and notify system to boot up. OFF will not.
Status	The status of UPS: <ul style="list-style-type: none"> • "Detecting..." • "Running" • "Unable to detect UPS" • "Communication lost" • "UPS reboot in progress" • "UPS shutdown in progress" • "Batteries failed. Please change them NOW!"

Battery Level (%)	Current power percentage of battery level.
--------------------------	--

4.5 System maintenance

“**Maintenance**” allows the operation of system functions which include “**System information**” to show the system version and details,, “**Upgrade**” to the latest firmware, “**Reset to factory default**” to reset all controller configuration values to factory settings, “**Import and export**” to import and export all controller configuration to a file, “**Event log**” to view system event log to record critical events, and “**Reboot and shutdown**” to reboot or shutdown the system.

System information	System information
Upgrade	Remote upload firmware
Reset to factory default	Reset to factory default
Import and export	Import/export configurations
Event log	System event log to record critical events
Reboot and shutdown	Reboot or shutdown system

Figure 4.5.1

4.5.1 System information

“**System information**” can display system information, including firmware version, CPU type, installed system memory, serial number and backplane ID.

System information
iR16FC4ER 1.0.8p2 (build 201011181700)
CPU type
XSC3-IOP8134x Family rev 9 (v5l)
Installed system memory
ECC Unbuffered DDR-II 2048MB
Controller serial no.
001378AC02BA
Backplane ID
C60

Figure 4.5.1.1

4.5.2 Upgrade

“Upgrade” can upgrade firmware. Please prepare new firmware file named “xxxx.bin” in local hard drive, then click “Browse” to select the file. Click “Confirm”, it will pop up a message “Upgrade system now? If you want to downgrade to the previous FW later (not recommend), please export your system configuration in advance”, click “Cancel” to export system configuration in advance, then click “OK” to start to upgrade firmware.



Figure 4.5.2.1



Figure 4.5.2.2

When upgrading, there is a progress bar running. After finished upgrading, the system must reboot manually to make the new firmware took effect.



Tips
Please contact with info@iStoragePro.com for latest firmware.

4.5.3 Reset to factory default

“Reset to factory default” allows user to reset controller to factory default setting.



Figure 4.5.3.1

Reset to default value, the password is: **0000**, and IP address to default DHCP.
Default IP address: **192.168.10.50** (DHCP)
Default subnet mask: **255.255.255.0**
Default gateway: **192.168.10.254**

4.5.4 Import and export

“**Import and export**” allows user to save system configuration values: export, and apply all configuration: import. For the volume configuration setting, the values are available in export and not available in import which can avoid conflict / date-deleting between two controllers which mean if one system already has valuable volumes in the disks and user may forget and overwrite it. Use import could return to original configuration. If the volume setting was also imported, user’s current volumes will be overwritten with different configuration.



Figure 4.5.4.1

1. **Import:** Import all system configurations excluding volume configuration.
2. **Export:** Export all configurations to a file.

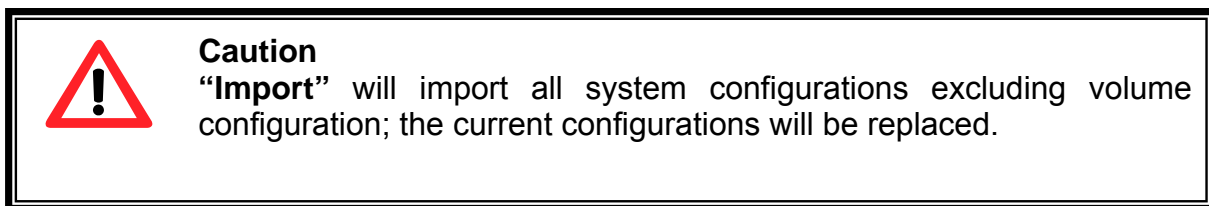

4.5.5 Event log

“**Event log**” can view the event messages. Check the checkbox of INFO, WARNING, and ERROR to choose the level of event log display. Click “**Download**” button to save the whole event log as a text file with file name “log-ModelName-SerialNumber-Date-Time.txt”. Click “**Clear**” button to clear all event logs. Click “**Mute**” button to stop alarm if system alerts.

Show events : INFO WARNING ERROR

Type	Time	Content
INFO	Wed, 01 Dec 2010 23:20:40	VD VD-R5-2 completed initialization.
INFO	Wed, 01 Dec 2010 23:20:34	Assign PD 4 to Global Spare Disks.
INFO	Wed, 01 Dec 2010 23:16:00	VD VD-R5-2 starts initialization.
INFO	Wed, 01 Dec 2010 23:16:00	VD VD-R5-1 completed initialization.
INFO	Wed, 01 Dec 2010 23:12:46	VD VD-R5-2 has been created.
INFO	Wed, 01 Dec 2010 23:12:20	VD VD-R5-1 starts initialization.
INFO	Wed, 01 Dec 2010 23:12:20	VD VD-R5-1 has been created.
INFO	Wed, 01 Dec 2010 23:09:10	RG RG-R5 has been created.
INFO	Wed, 01 Dec 2010 23:07:26	RG RG-R0 has been deleted.
INFO	Wed, 01 Dec 2010 23:07:21	RG RG-R5 has been deleted.
INFO	Wed, 01 Dec 2010 23:07:05	VD SnapVD-02 has been deleted.
INFO	Wed, 01 Dec 2010 23:07:05	VD SnapVD-01 has been deleted.
INFO	Wed, 01 Dec 2010 23:07:05	VD VD-01 has been deleted.
INFO	Wed, 01 Dec 2010 23:06:59	VD VD-02 has been deleted.
INFO	Wed, 01 Dec 2010 22:51:55	VD SnapVD-02 has been created.

Figure 4.5.5.1

The event log is displayed in reverse order which means the latest event log is on the first / top page. The event logs are actually saved in the first four hard drives; each hard drive has one copy of event log. For one system, there are four copies of event logs to make sure users can check event log any time when there are failed disks.



Tips
Please plug-in any of the first four hard drives, then event logs can be saved and displayed in next system boot up. Otherwise, the event logs cannot be saved and would be disappeared.

4.5.6 Reboot and shutdown

“Reboot and shutdown” can “Reboot” and “Shutdown” the system. Before power off, it’s better to execute “Shutdown” to flush the data from cache to physical disks. The step is necessary for data protection.



Figure 4.5.6.1

4.6 Logout

For security reason, “Logout” allows users logout when no user is operating the system. Re-login the system; please enter username and password again.

Chapter 5 Advanced operations

5.1 Volume rebuild

If one physical disk of the RG which is set as protected RAID level (e.g.: RAID 3, RAID 5, or RAID 6) is FAILED or has been unplugged / removed, then the status of RG is changed to degraded mode, the system will search/detect spare disk to rebuild the degraded RG to a complete one. It will detect dedicated spare disk as rebuild disk first, then global spare disk.

iStoragePro controllers support Auto-Rebuild. The following is the scenario:

Take RAID 6 for example:

1. When there is no global spare disk or dedicated spare disk in the system, The RG will be in degraded mode and wait until (1) there is one disk assigned as spare disk, or (2) the failed disk is removed and replaced with new clean disk, then the Auto-Rebuild starts. The new disk will be a spare disk to the original RG automatically. If the new added disk is not clean (with other RG information), it would be marked as RS (reserved) and the system will not start "auto-rebuild". If this disk is not belonging to any existing RG, it would be FR (Free) disk and the system will start Auto-Rebuild. If user only removes the failed disk and plugs the same failed disk in the same slot again, the auto-rebuild will start running. But rebuilding in the same failed disk may impact customer data if the status of disk is unstable. **iStoragePro** suggests all customers not to rebuild in the failed disk for better data protection.
2. When there is enough global spare disk(s) or dedicated spare disk(s) for the degraded array, system starts Auto-Rebuild immediately. And in RAID 6, if there is another disk failure occurs during rebuilding, system will start the above Auto-Rebuild process as well. Auto-Rebuild feature only works at that the status of RG is "**Online**". It will not work at "**Offline**". Thus, it will not conflict with the "**Online roaming**" feature.
3. In degraded mode, the status of RG is "**Degraded**". When rebuilding, the status of RG / VD will be "**Rebuild**", the column "**R%**" in VD will display the ratio in percentage. After complete rebuilding, the status will become "Online". RG will become completely one.



Tips

"**Set dedicated spare**" is not available if there is no RG or only RG of RAID 0, JBOD, because user can not set dedicated spare disk to RAID 0 and JBOD.

Sometimes, rebuild is called recover; they are the same meaning. The following table is the relationship between RAID levels and rebuild.

- **Rebuild operation description:**

RAID 0	Disk striping. No protection for data. RG fails if any hard drive fails or unplugs.
RAID 1	Disk mirroring over 2 disks. RAID 1 allows one hard drive fails or unplugging. Need one new hard drive to insert to the system and rebuild to be completed.
N-way mirror	Extension to RAID 1 level. It has N copies of the disk. N-way mirror allows N-1 hard drives failure or unplugging.
RAID 3	Striping with parity on the dedicated disk. RAID 3 allows one hard drive failure or unplugging.
RAID 5	Striping with interspersed parity over the member disks. RAID 5 allows one hard drive failure or unplugging.
RAID 6	2-dimensional parity protection over the member disks. RAID 6 allows two hard drives failure or unplugging. If it needs to rebuild two hard drives at the same time, it will rebuild the first one, then the other in sequence.
RAID 0+1	Mirroring of RAID 0 volumes. RAID 0+1 allows two hard drive failures or unplugging, but at the same array.
RAID 10	Striping over the member of RAID 1 volumes. RAID 10 allows two hard drive failure or unplugging, but in different arrays.
RAID 30	Striping over the member of RAID 3 volumes. RAID 30 allows two hard drive failure or unplugging, but in different arrays.
RAID 50	Striping over the member of RAID 5 volumes. RAID 50 allows two hard drive failures or unplugging, but in different arrays.
RAID 60	Striping over the member of RAID 6 volumes. RAID 60 allows four hard drive failures or unplugging, every two in different arrays.
JBOD	The abbreviation of “ J ust a B unch O f D isks”. No data protection. RG fails if any hard drive failures or unplugs.

5.2 RG migration

To migrate the RAID level, please follow below procedures.

1. Select “/ **Volume configuration / RAID group**”.
2. Check the gray button next to the RG number; click “**Migrate**”.
3. Change the RAID level by clicking the down arrow to “**RAID 5**”. There will be a pup-up which indicates that HDD is not enough to support the new setting of RAID level, click “**Select PD**” to increase hard drives, then click “**Confirm**” to go back to setup page. When doing migration to lower RAID level, such as the original RAID level is RAID 6 and user wants to migrate to RAID 0, system will evaluate whether this operation is safe or not, and appear a warning message of “**Sure to migrate to a lower protection array?**”.

Figure 5.2.1

4. Double check the setting of RAID level and RAID PD slot. If there is no problem, click “**Next**”.
5. Finally a confirmation page shows the detail of RAID information. If there is no problem, click “**Confirm**” to start migration. System also pops up a message of “**Warning: power lost during migration may cause damage of data!**” to give user warning. When the power is abnormally off during the migration, the data is in high risk.
6. Migration starts and it can be seen from the “**status**” of a RG with “**Migrating**”. In “/ **Volume configuration / Virtual disk**”, it displays a “**Migrating**” in “**Status**” and complete percentage of migration in “**R%**”.

No.	Name	Total (GB)	Free (GB)	#PD	#VD	Status	Health	RAID	Enclosure
1	RG-R0-R5	5588	5568	4	1	Migrating	Good	RAID 5	Local

Figure 5.2.2

(Figure 5.2.2: A RAID 0 with 3 physical disks migrates to RAID 5 with 4 physical disks.) (IR16FC4ER does not have “Enclosure” column.)

No.	Name	Size (GB)	Write	Priority	Bg rate	Status	Clone	Schedule	Type	Health	R %	RAID	#LUN	Snapshot space (GB)	#Snapshot	RG name
1	VD-R0->R5	20	WB	HI	4	Migrating	N/A	N/A	RAID	Optimal	1	RAID 5	0	0/0	0	RG-R0-R5

Figure 5.2.3

To do migration, the total size of RG must be larger or equal to the original RG. It does not allow expanding the same RAID level with the same hard disks of original RG.

The below operations are not allowed when a RG is being migrated. System would reject these operations:

1. Add dedicated spare.
2. Remove a dedicated spare.
3. Create a new VD.
4. Delete a VD.
5. Extend a VD.
6. Scrub a VD.
7. Perform another migration operation.
8. Scrub entire RG.
9. Take a snapshot.
10. Delete a snapshot.
11. Expose a snapshot.
12. Rollback to a snapshot.



Caution
RG Migration cannot be executed during rebuilding or VD extension.

5.3 VD extension

To extend VD size, please follow the procedures.

1. Select “/ **Volume configuration / Virtual disk**”.
2. Check the gray button next to the VD number; click “**Extend**”.
3. Change the size. The size must be larger than the original, and then click “**Confirm**” to start extension.

Size : GB

Free : 5578 GB

Figure 5.3.1

4. Extension starts. If VD needs initialization, it will display an “**Initiating**” in “**Status**” and complete percentage of initialization in “**R%**”.

No.	Name	Size (GB)	Write	Priority	Bg rate	Status	Clone	Schedule	Type	Health	R %	RAID	#LUN	Snapshot space (GB)	#Snapshot	RG name
1	VD-R0->R5	20	WB	HI	4	Initiating	N/A	N/A	RAID	Optimal	55	RAID 5	0	0/0	0	RG-R0-R5

Figure 5.3.2



Tips

The size of VD extension must be larger than original.



Caution

VD Extension cannot be executed during rebuilding or migration.

5.4 iSnap

Snapshot-on-the-box (iSnap) captures the instant state of data in the target volume in a logical sense. The underlying logic is Copy-on-Write -- moving out the data which would be written to certain location where a write action occurs since the time of data capture. The certain location, named as “Snap VD”, is essentially a new VD which can be attached to a LUN provisioned to a host as a disk like other ordinary VDs in the system. Rollback restores the data back to the state of any time which was previously captured in case for any unfortunate reason it might be (e.g. virus attack, data corruption, human errors and so on). Snap VD is allocated within the same RG in which the snapshot is taken, we suggest to reserve 20% of RG size or more for snapshot space. Please refer to F the following figure for snapshot concept.

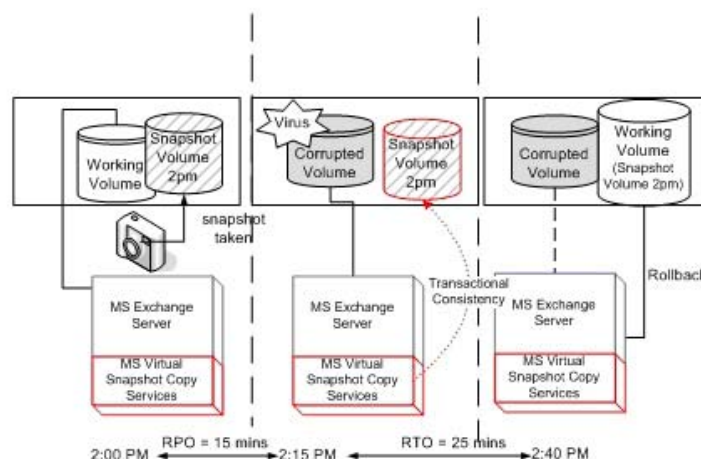

Figure 5.4.1

5.4.1 Create snapshot volume

To take a snapshot of the data, please follow the procedures.

1. Select “/ Volume configuration / Virtual disk”.
2. Check the gray button next to the VD number; click “Set snapshot space”.
3. Set up the size for snapshot. The minimum size is suggested to be **20%** of VD size, and then click “OK”. It will go back to the VD page and the size will show in snapshot column. It may not be the same as the number entered because some size is reserved for snapshot internal usage. There will be 2 numbers in “Snapshot” column. These numbers mean “Used snapshot space” and “Total snapshot space”.
4. There are two methods to take snapshot. In “/ Volume configuration / Virtual disk”, check the gray button next to the VD number; click “Take snapshot”. Or in “/ Volume configuration / Snapshot”, click “Take snapshot”.
5. Enter a snapshot name, and then click “OK”. A snapshot VD is created.
6. Select “/ Volume configuration / Snapshot” to display all snapshot VDs taken from the VD.

Linked snapshot for VD: - VD-01 -

No.	Name	Used (GB)	Status	Health	Exposure	Right	#LUN	Created time
1	SnapVD-01	0	N/A	Good	No	N/A	N/A	Thu Dec 2 04:29:07 2010

Expose
Rollback
Delete

<< Back Cleanup Auto snapshot Take snapshot

Figure 5.4.1.1

7. Check the gray button next to the Snapshot VD number; click “Expose”. Enter a capacity for snapshot VD. If size is zero, the exposed snapshot VD is read only. Otherwise, the exposed snapshot VD can be read / written, and the size is the maximum capacity to read / write. **IR16FC4ER** supports read-only, and **IR16FC4ER** supports writable snapshot.
8. Attach a LUN to the snapshot VD. Please refer to the previous chapter for attaching a LUN.
9. Done. It can be used as a disk.

Linked snapshot for VD: - VD-01 -

No.	Name	Used (GB)	Status	Health	Exposure	Right	#LUN	Created time
1	SnapVD-01	0	N/A	Good	Yes	Read-only	0	Wed Dec 8 16:46:43 2010
2	SnapVD-02	0	N/A	Good	Yes	Read-write	0	Wed Dec 8 16:47:20 2010

Unexpose
Rollback
Delete
Attach
Detach
List LUN

<< Back Cleanup Auto snapshot Take snapshot

Figure 5.4.1.2

(Figure 5.4.1.2: This is the snapshot list of “VD-01”. There are two snapshots. Snapshot VD “SnapVD-01” is exposed as read-only, “SnapVD-02” is exposed as read-write.) (IR16FC4ER supports read-only, IR16FC4ER supports read-write.)

1. There are two methods to clean all snapshots. In “/ Volume configuration / Virtual disk”, check the gray button next to the VD number; click “Cleanup snapshot”. Or in “/ Volume configuration / Snapshot”, click “Cleanup”.
2. “Cleanup” will delete all snapshots of the VD and release snapshot space.

5.4.2 Auto snapshot

The snapshot copies can be taken manually or by schedule such as hourly or daily. Please follow the procedures.

1. There are two methods to set auto snapshot. In “/ Volume configuration / Virtual disk”, check the gray button next to the VD number; click “Auto snapshot”. Or in “/ Volume configuration / Snapshot”, click “Auto snapshot”.
2. The auto snapshot can be set monthly, weekly, daily, or hourly.
3. Done. It will take snapshots automatically.

All
Months to take snapshots :
 01 02 03 04
 05 06 07 08
 09 10 11 12

All
Weeks to take snapshots :
 1 2 3 4
 5

All
Days to take snapshots :
 Sun Mon Tue Wed
 Thu Fri Sat

All
Hours to take snapshots :
 00 01 02 03
 04 05 06 07
 08 09 10 11
 12 13 14 15
 16 17 18 19
 20 21 22 23

Figure 5.4.2.1

(Figure 5.4.2.1: It will take snapshots every month, and keep the last 32 snapshot copies.)



Tips

Daily snapshot will be taken at every 00:00. Weekly snapshot will be taken every Sunday 00:00. Monthly snapshot will be taken every first day of month 00:00.

5.4.3 Rollback

The data in snapshot VD can rollback to original VD. Please follow the procedures.

1. Select “/ **Volume configuration / Snapshot**”.
2. Check the gray button next to the Snap VD number which user wants to rollback the data; click “**Rollback**”.
3. Done, the data in snapshot VD is rollback to original VD.



Caution

Before executing rollback, it is better to dismount file system for flushing data from cache to disks in OS first. System sends pop-up message when user executes rollback function.

5.4.4 iSnap constraint

iStoragePro snapshot function applies Copy-on-Write technique on UDV/VD and provides a quick and efficient backup methodology. When taking a snapshot, it does not copy any data at first time until a request of data modification comes in. The snapshot copies the original data to snapshot space and then overwrites the original data with new changes. With this technique, snapshot only copies the changed data instead of copying whole data. It will save a lot of disk space.

- **Create a data-consistent snapshot**

Before using snapshot, user has to know why sometimes the data corrupts after rollback of snapshot. Please refer to the following diagram.

When user modifies the data from host, the data will pass through file system and memory of the host (write caching). Then the host will flush the data from memory to physical disks, no matter the disk is local disk (IDE or SATA), DAS (SCSI or SAS), or SAN (fibre or iSCSI). From the viewpoint of storage device, it can not control the behavior of host side. This case maybe happens. If user takes a snapshot, some data is still in memory and not flush to disk. Then the snapshot may have an incomplete image of original data. The problem does not belong to the storage device. To avoid this data inconsistent issue between snapshot and original data, user has to make the operating system flush the data from memory of host (write caching) into disk before taking snapshot.

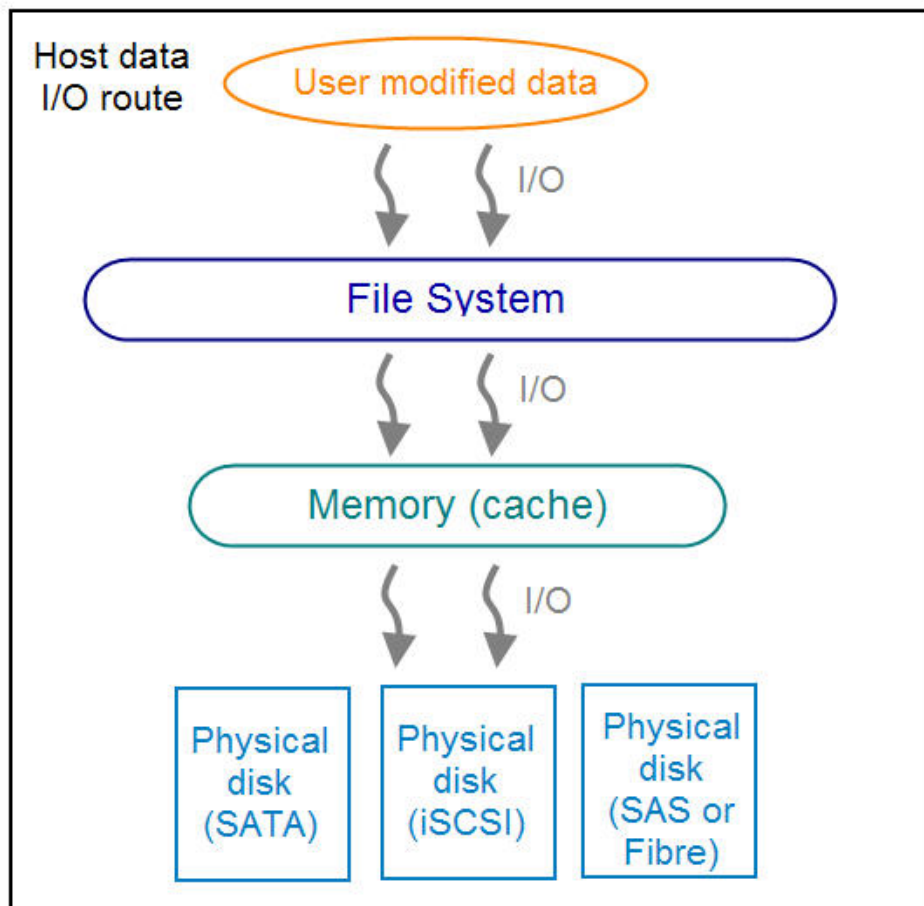

Figure 5.4.4.1

On Linux and UNIX platform, a command named **sync** can be used to make the operating system flush data from write caching into disk. For Windows platform, Microsoft also provides a tool – **sync**, which can do exactly the same thing as the **sync** command in Linux/UNIX. It will tell the OS to flush the data on demand. For more detail about **sync** tool, please refer to: <http://technet.microsoft.com/en-us/sysinternals/bb897438.aspx>

Besides the **sync** tool, Microsoft develops **VSS** (volume shadow copy service) to prevent this issue. VSS is a mechanism for creating consistent point-in-time copies of data known as shadow copies. It is a coordinator between backup software, application (SQL or Exchange...) and storages to make sure the snapshot without the problem of data-inconsistent. For more detail about the VSS, please refer to <http://technet.microsoft.com/en-us/library/cc785914.aspx>. **iStoragePro IR16FC4ER** can support Microsoft VSS.

- **What if the snapshot space is over?**

Before using snapshot, a snapshot space is needed from RG capacity. After a period of working snapshot, what if the snapshot size over the snapshot space of user defined? There are two different situations:

1. If there are two or more snapshots existed, the system will try to remove the oldest snapshots (to release more space for the latest snapshot) until enough space is released.
2. If there is only one snapshot existed, the snapshot will fail. Because the snapshot space is run out.

For example, there are two or more snapshots existed on a VD and the latest snapshot keeps growing. When it comes to the moment that the snapshot space is run out, the system will try to remove the oldest snapshot to release more space for the latest snapshot usage. As the latest snapshot is growing, the system keeps removing the old snapshots. When it comes that the latest snapshot is the only one in system, there is no more snapshot space which can be released for incoming changes, then snapshot will fail.

- **How many snapshots can be created on a VD**

There are up to 32 snapshots can be created on a UDV/VD. What if the 33rd snapshot has been taken? There are two different situations:

1. If the snapshot is configured as **auto snapshot**, the latest one (the 33rd snapshot) will replace the oldest one (the first snapshot) and so on.
2. If the snapshot is taken manually, when taking the 33rd snapshot will fail and a warning message will be showed on Web UI.

- **Rollback / Delete snapshot**

When a snapshot has been rollbacked, the other snapshots which are earlier than it will also be removed. But the rest snapshots will be kept after rollback. If a snapshot has been deleted, the other snapshots which are earlier than it will also be deleted. The space occupied by these snapshots will be released after deleting.

5.5 Disk roaming

Physical disks can be re-sequenced in the same system or move all physical disks in the same RAID group from system-1 to system-2. This is called disk roaming. System can execute disk roaming online. Please follow the procedures.

1. Select “/ **Volume configuration / RAID group**”.
2. Check the gray button next to the RG number; click “**Deactivate**”.
3. Move all PDs of the RG to another system.
4. Check the gray button next to the RG number; click “**Activate**”.
5. Done.

Disk roaming has some constraints as described in the followings:

1. Check the firmware version of two systems first. It is better that either systems have the same firmware version or system-2 firmware version is newer.

2. All physical disks of the RG should be moved from system-1 to system-2 together. The configuration of both RG and VD will be kept but LUN configuration will be cleared in order to avoid conflict with system-2's original setting.

5.6 VD clone

The user can use VD clone function to backup data from source VD to target VD, set up backup schedule, and deploy the clone rules.

The procedures of VD clone are on the following:

1. Copy all data from source VD to target VD at the beginning (full copy).
2. Use iSnap technology to perform the incremental copy afterwards. Please be fully aware that the incremental copy needs to use snapshot to compare the data difference. Therefore, the enough snapshot space for VD clone is very important.

The following contents will take an example of a RAID 5 virtual disk (SourceVD_Raid5) clone to RAID 6 virtual disk (TargetVD_Raid6).

- **Start VD clone**

1. Create a RAID group (RG) in advance.

No.	Name	Total (GB)	Free (GB)	#PD	#VD	Status	Health	RAID	Enclosure
1	RG-R5	3725	3725	3	0	Online	Good	RAID 5	Local
2	RG-R6	3725	3725	4	0	Online	Good	RAID 6	Local

Figure 5.6.1

2. Create two virtual disks (VD) "SourceVD_R5" and "TargetVD_R6". The raid type of backup target needs to be set as "**BACKUP**".

Name : TargetVD-R6
RG name : RG-R6
Capacity : 20 GB
Stripe height (KB) : 64
Block size (B) : 512
Read/Write : Write-through cache Write-back cache
Priority : High priority Middle priority Low priority
Bg rate : 4
Readahead : Enabled
Erase : None
Type : BACKUP
RAID
BACKUP

Figure 5.6.2

- Here are the objects, a Source VD and a Target VD. Before starting clone process, it needs to deploy the VD Clone rule first. Click “**Configuration**”.

No.	Name	Size (GB)	Write	Priority	Bg rate	Status	Clone	Schedule	Type	Health	R%	RAID	#LUN	Snapshot space (GB)	#Snapshot	RG name
1	SourceVD_R5	20	WB	HI	4	Online	N/A	N/A	RAID	Optimal		RAID 5	0	0/0	0	RG-R5
2	TargetVD-R6	20	WB	HI	4	Online	N/A	N/A	BACKUP	Optimal		RAID 6	0	0/0	0	RG-R6

Figure 5.6.3

- There are three clone configurations, describe on the following.

Snapshot space : 2
Threshold : 50%
Restart the task an hour later if failed :

Figure 5.6.4

- Snapshot space:**

Snapshot space : 2
Threshold : 50%
Restart the task an hour later if failed :

Figure 5.6.4

This setting is the ratio of source VD and snapshot space. The default ratio is 2 to 1. It means when the clone process is starting, the system will automatically use the free RG space to create a snapshot space which capacity is double the source VD.

- **Threshold: (The setting will be effective after enabling schedule clone)**

The screenshot shows three configuration items: 'Snapshot space' with a dropdown menu set to '2', 'Threshold' with a dropdown menu set to '50%', and 'Restart the task an hour later' with a dropdown menu showing options '40%', '50%', and '60%', and an unchecked checkbox to its right.

Figure 5.6.5

The threshold setting will monitor the usage amount of snapshot space. When the used snapshot space achieves its threshold, system will automatically take a clone snapshot and start VD clone process. The purpose of threshold could prevent the incremental copy fail immediately when running out of snapshot space.

For example, the default threshold is 50%. The system will check the snapshot space every hour. When the snapshot space is used over 50%, the system will synchronize the source VD and target VD automatically. Next time, when the rest snapshot space has been used 50%, in other words, the total snapshot space has been used 75%, the system will synchronize the source VD and target VD again.

- **Restart the task an hour later if failed: (The setting will be effective after enabling schedule clone)**

The screenshot shows three configuration items: 'Snapshot space' with a dropdown menu set to '2', 'Threshold' with a dropdown menu set to '50%', and 'Restart the task an hour later if failed' with a checked checkbox.

Figure 5.6.6

When running out of snapshot space, the VD clone process will be stopped because there is no more available snapshot space. If this option has been checked, system will clear the snapshots of clone in order to release snapshot space automatically, and the VD clone will restart the task after an hour. This task will start a full copy.

5. After deploying the VD clone rule, the VD clone process can be started now. Firstly, Click “**Set clone**” to set the target VD at the VD name “SourceVD_R5”.

No.	Name	Size (GB)	Write	Priority	Bg rate	Status	Clone	Schedule	Type	Health	R %	RAID	#LUN	Snapshot space (GB)	#Snapshot	RG name
1	SourceVD_R5	20	WB	HI	4	Online	N/A	N/A	RAID	Optimal		RAID 5	0	0/0	0	RG-R5
			WB	HI	4	Online	N/A	N/A	BACKUP	Optimal		RAID 6	0	0/0	0	RG-R6

- Extend
- Parity check
- Delete
- Set property
- Attach LUN
- Detach LUN
- List LUN
- Set done
- Set snapshot space
- Cleanup snapshot
- Take snapshot
- Auto snapshot
- List snapshot
- More information

Figure 5.6.7

6. Select the target VD. Then click “**Confirm**”.

Name :

Figure 5.6.8

7. Now, the clone target “TargetVD_R6” has been set.

No.	Name	Size (GB)	Write	Priority	Bg rate	Status	Clone	Schedule	Type	Health	R %	RAID	#LUN	Snapshot space (GB)	#Snapshot	RG name
1	SourceVD_R5	20	WB	HI	4	Online	TargetVD-R6	N/A	RAID	Optimal		RAID 5	0	0/0	0	RG-R5
2	TargetVD-R6	20	WB	HI	4	Online	N/A	N/A	BACKUP	Optimal		RAID 6	0	0/0	0	RG-R6

Figure 5.6.9

8. Click “**Start clone**”, the clone process will start.

No.	Name	Size (GB)	Write	Priority	Bg rate	Status	Clone	Schedule	Type	Health	R %	RAID	#LUN	Snapshot space (GB)	#Snapshot	RG name
1	SourceVD_R5	20	WB	HI	4	Online	N/A	N/A	RAID	Optimal		RAID 5	0	0/0	0	RG-R5
			WB	HI	4	Online	N/A	N/A	BACKUP	Optimal		RAID 6	0	0/0	0	RG-R6

Extend
 Parity check
 Delete
 Set property
 Attach LUN
 Detach LUN
 List LUN
 ▶ Set done
 Set snapshot space
 Cleanup snapshot
 Take snapshot
 Auto snapshot
 List snapshot
 More information

Figure 5.6.10

- The default setting will create a snapshot space automatically which the capacity is double size of the VD space. Before starting clone, system will initiate the snapshot space.

No.	Name	Size (GB)	Write	Priority	Bg rate	Status	Clone	Schedule	Type	Health	R %	RAID	#LUN	Snapshot space (GB)	#Snapshot	RG name
1	SourceVD_R5	20	WB	HI	4	Initiating	TargetVD-R6	N/A	RAID	Optimal	33	RAID 5	0	3/43	1	RG-R5
2	TargetVD-R6	20	WB	HI	4	Online	N/A	N/A	BACKUP	Optimal		RAID 6	0	0/0	0	RG-R6

Figure 5.6.11

- After initiating the snapshot space, it will start cloning.

No.	Name	Size (GB)	Write	Priority	Bg rate	Status	Clone	Schedule	Type	Health	R %	RAID	#LUN	Snapshot space (GB)	#Snapshot	RG name
1	SourceVD_R5	20	WB	HI	4	Cloning	TargetVD-R6	N/A	RAID	Optimal	32	RAID 5	0	3/23	1	RG-R5
2	TargetVD-R6	20	WB	HI	4	Online	N/A	N/A	BACKUP	Optimal		RAID 6	0	0/0	0	RG-R6

Figure 5.6.12

- Click “**Schedule clone**” to set up the clone by schedule.

No.	Name	Size (GB)	Write	Priority	Bg rate	Status	Clone	Schedule	Type	Health	R %	RAID	#LUN	Snapshot space (GB)	#Snapshot	RG name
1	SourceVD_R5	20	WB	HI	4	Online	TargetVD-R6	N/A	RAID	Optimal		RAID 5	0	3/43	1	RG-R5
			WB	HI	4	Online	N/A	N/A	BACKUP	Optimal		RAID 6	0	0/0	0	RG-R6

- Extend
- Parity check
- Delete
- Set property
- Attach LUN
- Detach LUN
- List LUN
- Clear done
- Start done
- Stop done
- Schedule done
- Set snapshot space
- Cleanup snapshot
- Take snapshot
- Auto snapshot
- List snapshot
- More information

Figure 5.6.13

12. There are “**Set Clone schedule**” and “**Clear Clone schedule**” in this page. Please remember that “**Threshold**” and “**Restart the task an hour later if failed**” options in VD configuration will take effect after clone schedule has been set.

Virtual disk:SourceVD_R5

Set Clone schedule

Scheduled time : 00:00

Back up everyday

Back up on a selected day in a week

Sunday Monday Tuesday Wednesday
 Thursday Friday Saturday

Back up on the 1st day in a month

Clear Clone schedule

Figure 5.6.14

- **Run out of snapshot space while VD clone**

While the clone is processing, the increment data of this VD is over the snapshot space. The clone will complete, but the clone snapshot will fail. Next time, when trying to start clone, it will get a warning message “This is not enough of snapshot space for the operation”. At this time, the user needs to clean up the snapshot space in order to operate the clone process. Each time the clone snapshot failed, it means

that the system loses the reference value of incremental data. So it will start a full copy at next clone process.

When running out of snapshot space, the flow diagram of VD clone procedure will be like the following.

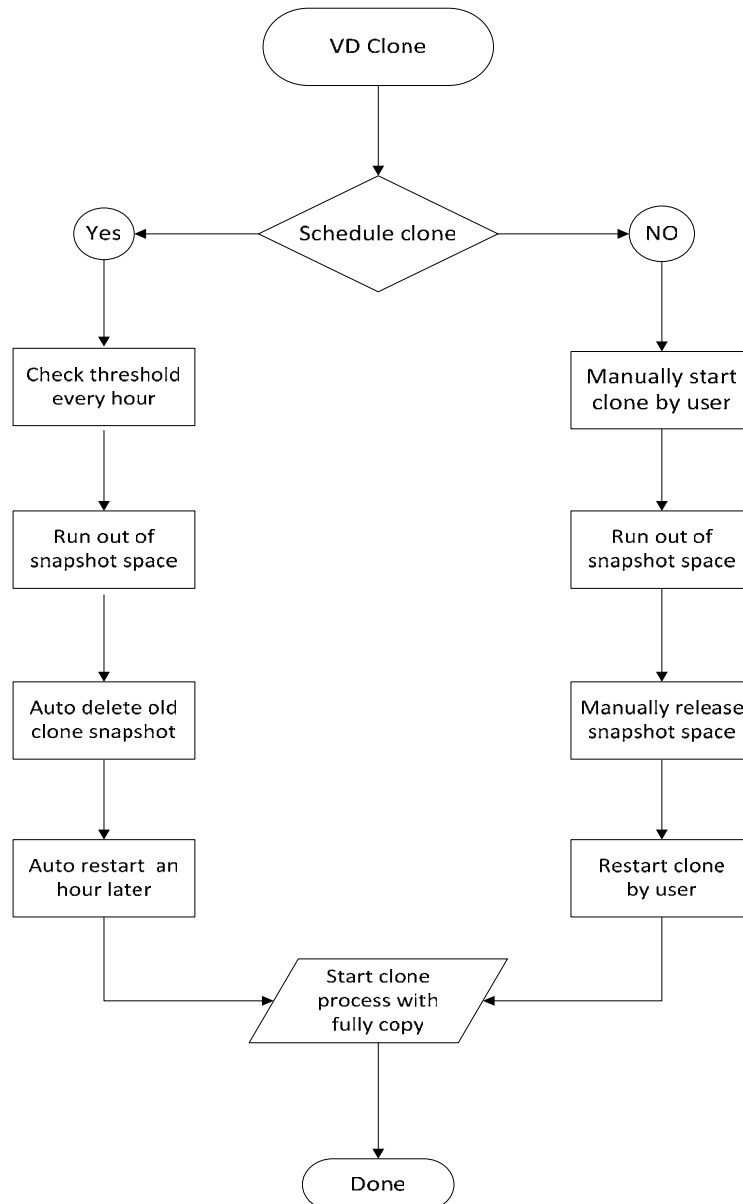

Figure 5.6.15

5.7 SAS JBOD expansion

5.7.1 Connecting JBOD

IR16FC4ER has SAS JBOD expansion port to connect extra SAS JBOD controllers. When connecting to a SAS JBOD which can be detected, it displays tabs on the top in “/ **Volume configuration / Physical disk**”. For example, Local, JBOD 1 (vendor model), JBOD 2 (vendor model), ...etc. Local means disks in local controller, and so

on. The disks in JBOD can be used as local disks.

Local [JBOD 1 \(iStorage iR16SAEJ v1.1.1\)](#)

Slot	Size (GB)	RG name	Status	Health	Usage	Vendor	Serial	Type	Write cache	Standby	Readahead	Command queuing
1	1862		Online	Good	Free disk	WDC	WD-WMAY00026111	SATA2	Enabled	Disabled	Enabled	Enabled
2	1862		Online	Good	Free disk	WDC	WD-WMAUR0039716	SATA2	Enabled	Disabled	Enabled	Enabled
3	1862		Online	Good	Free disk	WDC	WD-WMAY00025408	SATA2	Enabled	Disabled	Enabled	Enabled
4	1862		Online	Good	Free disk	WDC	WD-WMAUR0014142	SATA2	Enabled	Disabled	Enabled	Enabled
5	1862		Online	Good	Free disk	WDC	WD-WMAY00016042	SATA2	Enabled	Disabled	Enabled	Enabled
6	1862		Online	Good	Free disk	WDC	WD-WMAY00032068	SATA2	Enabled	Disabled	Enabled	Enabled
7	1862		Online	Good	Free disk	WDC	WD-WMAUR0111016	SATA2	Enabled	Disabled	Enabled	Enabled
8	1862		Online	Good	Free disk	WDC	WD-WMAY00037129	SATA2	Enabled	Disabled	Enabled	Enabled

Figure 5.7.1

(Figure 5.7.1: Display all PDs in JBOD 1.)

“/ Enclosure management / S.M.A.R.T.” can display S.M.A.R.T. information of all PDs, including Local and all SAS JBODs.

Local

Slot	HDD type	Read error rate	Spin up time	Reallocated sector count	Seek error rate	Spin up retries	Calibration retries	Temperature (C)
1	SATA2	200(51)	173(21)	200(140)	200(0)	100(0)	100(0)	30
2	SATA2	200(51)	167(21)	200(140)	100(0)	100(0)	100(0)	32
3	SATA2	200(51)	169(21)	200(140)	100(0)	100(0)	100(0)	31
4	SATA2	200(51)	166(21)	200(140)	200(0)	100(0)	100(0)	32
5	SATA2	200(51)	166(21)	200(140)	200(0)	100(0)	100(0)	32
6	SATA2	200(51)	169(21)	200(140)	200(0)	100(0)	100(0)	31
7	SATA2	200(51)	172(21)	200(140)	200(0)	100(0)	100(0)	31
8	SATA2	200(51)	177(21)	199(140)	200(0)	100(0)	100(0)	30

JBOD 1: iStorage iR16SAEJ v1.1.1 (WWN: 500137800290B23F)

Slot	HDD type	Read error rate	Spin up time	Reallocated sector count	Seek error rate	Spin up retries	Calibration retries	Temperature (C)
1	SATA2	200(51)	169(21)	200(140)	200(0)	100(0)	100(0)	29
2	SATA2	200(51)	181(21)	200(140)	200(0)	100(0)	100(0)	30
3	SATA2	200(51)	169(21)	200(140)	200(0)	100(0)	100(0)	30
4	SATA2	200(51)	158(21)	200(140)	200(0)	100(0)	100(0)	31
5	SATA2	200(51)	163(21)	200(140)	200(0)	100(0)	100(0)	28
6	SATA2	200(51)	161(21)	200(140)	200(0)	100(0)	100(0)	30
7	SATA2	200(51)	161(21)	200(140)	200(0)	100(0)	100(0)	31
8	SATA2	183(51)	164(21)	152(140)	200(0)	100(0)	100(0)	29

Figure 5.7.2

(Figure 5.7.2: Disk S.M.A.R.T. information of Local and JBOD 1, although S.M.A.R.T. supports SATA disk only.)

SAS JBOD expansion has some constraints as described in the followings:

1. Up to 4 SAS JBODs can be cascaded.
2. Created RG can not use PDs which located in different systems. It means that RG can be composed of PDs which are all in Local or one SAS JBOD.
3. Global spare disk only supports all RGs which located in the same system.

5.7.2 Upgrade firmware of JBOD

To upgrade the firmware of JBOD, please follow the procedures.

- 1 There is a hidden web page for JBOD firmware upgrade. Please login Web UI as username admin first, and then add this URL to the browser. (http://Management IP/jbod_upg.php), for example:

http://192.168.10.50/jbod_upg.php

FOLLOW THE STEPS TO UPGRADE THE FIRMWARE OF JBOD

Step 1: Choose a JBOD :

Step 2: Browse the firmware to upgrade :

Step 3: Make sure Step 1 & 2 is correct, then Confirm!

Figure 5.7.2.1

- 2 Choose a JBOD which wants to upgrade.
- 3 Please prepare new firmware file in local hard drive, then click “**Browse**” to select the file. Click “**Confirm**”.
- 4 After finished upgrading, the system must reboot manually to make the new firmware took effect.

Chapter 6 Troubleshooting

6.1 System buzzer

The system buzzer features are listed below:

1. The system buzzer alarms 1 second when system boots up successfully.
2. The system buzzer alarms continuously when there is error occurred. The alarm will be stopped after error resolved or be muted.
3. The alarm will be muted automatically when the error is resolved. E.g., when RAID 5 is degraded and alarm rings immediately, user changes / adds one physical disk for rebuilding. When the rebuilding is done, the alarm will be muted automatically.

6.2 Event notifications

- **PD events**

Level	Type	Description
INFO	PD inserted	Disk <slot> is inserted into system
WARNING	PD removed	Disk <slot> is removed from system
ERROR	HDD read error	Disk <slot> read block error
ERROR	HDD write error	Disk <slot> write block error
ERROR	HDD error	Disk <slot> is disabled
ERROR	HDD IO timeout	Disk <slot> gets no response
INFO	PD upgrade started	PD [<string>] starts upgrading firmware process.
INFO	PD upgrade finished	PD [<string>] finished upgrading firmware process.
WARNING	PD upgrade failed	PD [<string>] upgrade firmware failed.

- **HW events**

Level	Type	Description
WARNING	ECC single	Single-bit ECC error is detected at <address>
ERROR	ECC multiple	Multi-bit ECC error is detected at <address>
INFO	ECC dimm	ECC memory is installed
INFO	ECC none	Non-ECC memory is installed
INFO	SCSI bus reset	Received SCSI Bus Reset event at the SCSI Bus <number>
ERROR	SCSI host error	SCSI Host allocation failed
ERROR	SATA enable device fail	Failed to enable the SATA pci device
ERROR	SATA EDMA mem fail	Failed to allocate memory for SATA EDMA
ERROR	SATA remap mem fail	Failed to remap SATA memory io spcae
ERROR	SATA PRD mem	Failed to init SATA PRD memory manager

	fail	
ERROR	SATA revision id fail	Failed to get SATA revision id
ERROR	SATA set reg fail	Failed to set SATA register
ERROR	SATA init fail	Core failed to initialize the SATA adapter
ERROR	SATA diag fail	SATA Adapter diagnostics failed
ERROR	Mode ID fail	SATA Mode ID failed
ERROR	SATA chip count error	SATA Chip count error
INFO	SAS port reply error	SAS HBA port <number> reply terminated abnormally
INFO	SAS unknown port reply error	SAS frontend reply terminated abnormally
INFO	FC port reply error	FC HBA port <number> reply terminated abnormally
INFO	FC unknown port reply error	FC frontend reply terminated abnormally

- **EMS events**

Level	Type	Description
INFO	Power install	Power(<string>) is installed
ERROR	Power absent	Power(<string>) is absent
INFO	Power restore	Power(<string>) is restored to work.
ERROR	Power fail	Power(<string>) is not functioning
WARNING	Power detect	PSU signal detection(<string>)
INFO	Fan restore	Fan(<string>) is restored to work.
ERROR	Fan fail	Fan(<string>) is not functioning
INFO	Fan install	Fan(<string>) is installed
ERROR	Fan not present	Fan(<string>) is not present
ERROR	Fan over speed	Fan(<string>) is over speed
WARNING	Thermal level 1	System temperature(<string>) is higher.
ERROR	Thermal level 2	System Overheated(<string>)!!!
ERROR	Thermal level 2 shutdown	System Overheated(<string>)!!! The system will auto-shutdown immediately.
ERROR	Thermal level 2 CTR shutdown	The controller will auto shutdown immediately, reason [Overheated(<string>)].
WARNING	Thermal ignore value	Unable to update thermal value on <string>
WARNING	Voltage level 1	System voltage(<string>) is higher/lower.
ERROR	Voltage level 2	System voltages(<string>) failed!!!
ERROR	Voltage level 2 shutdown	System voltages(<string>) failed!!! The system will auto-shutdown immediately.
ERROR	Voltage level 2 CTR shutdown	The controller will auto shutdown immediately, reason [Voltage abnormal(<string>)].
INFO	UPS OK	Successfully detect UPS
WARNING	UPS fail	Failed to detect UPS
ERROR	UPS AC loss	AC loss for system is detected
ERROR	UPS power low	UPS Power Low!!! The system will auto-shutdown immediately.
WARNING	SMART T.E.C.	Disk <slot> S.M.A.R.T. Threshold Exceed Condition occurred for attribute <string>
WARNING	SMART fail	Disk <slot>: Failure to get S.M.A.R.T information
WARNING	RedBoot failover	RedBoot failover event occurred
WARNING	Watchdog shutdown	Watchdog timeout shutdown occurred
WARNING	Watchdog reset	Watchdog timeout reset occurred

- **RMS events**

Level	Type	Description
INFO	Console Login	<username> login from <IP or serial console> via Console UI
INFO	Console Logout	<username> logout from <IP or serial console> via Console UI
INFO	Web Login	<username> login from <IP> via Web UI
INFO	Web Logout	<username> logout from <IP> via Web UI
INFO	Log clear	All event logs are cleared
WARNING	Send mail fail	Failed to send event to <email>.

- **LVM events**

Level	Type	Description
INFO	RG create OK	RG <name> has been created.
INFO	RG create fail	Failed to create RG <name>.
INFO	RG delete	RG <name> has been deleted.
INFO	RG rename	RG <name> has been renamed as <name>.
INFO	VD create OK	VD <name> has been created.
INFO	VD create fail	Failed to create VD <name>.
INFO	VD delete	VD <name> has been deleted.
INFO	VD rename	Name of VD <name> has been renamed to <name>.
INFO	VD read only	Cache policy of VD <name> has been set as read only.
INFO	VD write back	Cache policy of VD <name> has been set as write-back.
INFO	VD write through	Cache policy of VD <name> has been set as write-through.
INFO	VD extend	Size of VD <name> extends.
INFO	VD attach LUN OK	VD <name> has been LUN-attached.
INFO	VD attach LUN fail	Failed to attach LUN to VD <name>.
INFO	VD detach LUN OK	VD <name> has been detached.
INFO	VD detach LUN fail	Failed to attach LUN from bus <number>, SCSI ID <number>, lun <number>.
INFO	VD init started	VD <name> starts initialization.
INFO	VD init finished	VD <name> completes initialization.
WARNING	VD init failed	Failed to complete initialization of VD <name>.
INFO	VD rebuild started	VD <name> starts rebuilding.
INFO	VD rebuild finished	VD <name> completes rebuilding.
WARNING	VD rebuild failed	Failed to complete rebuild of VD <name>.
INFO	VD migrate started	VD <name> starts migration.
INFO	VD migrate finished	VD <name> completes migration.
ERROR	VD migrate failed	Failed to complete migration of VD <name>.
INFO	VD scrub started	Parity checking on VD <name> starts.
INFO	VD scrub finished	Parity checking on VD <name> completes with <address> parity/data inconsistency found.
INFO	VD scrub aborted	Parity checking on VD <name> stops with <address> parity/data inconsistency found.
INFO	RG migrate started	RG <name> starts migration.
INFO	RG migrate finished	RG <name> completes migration.
INFO	RG move started	RG <name> starts move.
INFO	RG move finished	RG <name> completes move.
INFO	VD move started	VD <name> starts move.

INFO	VD move finished	VD <name> completes move.
ERROR	VD move failed	Failed to complete move of VD <name>.
INFO	RG activated	RG <name> has been manually activated.
INFO	RG deactivated	RG <name> has been manually deactivated.
INFO	VD rewrite started	Rewrite at LBA <address> of VD <name> starts.
INFO	VD rewrite finished	Rewrite at LBA <address> of VD <name> completes.
WARNING	VD rewrite failed	Rewrite at LBA <address> of VD <name> failed.
WARNING	RG degraded	RG <name> is in degraded mode.
WARNING	VD degraded	VD <name> is in degraded mode.
ERROR	RG failed	RG <name> is failed.
ERROR	VD failed	VD <name> is failed.
ERROR	VD IO fault	I/O failure for stripe number <address> in VD <name>.
WARNING	Recoverable read error	Recoverable read error occurred at LBA <address>-<address> of VD <name>.
WARNING	Recoverable write error	Recoverable write error occurred at LBA <address>-<address> of VD <name>.
ERROR	Unrecoverable read error	Unrecoverable read error occurred at LBA <address>-<address> of VD <name>.
ERROR	Unrecoverable write error	Unrecoverable write error occurred at LBA <address>-<address> of VD <name>.
ERROR	Config read fail	Config read failed at LBA <address>-<address> of PD <slot>.
ERROR	Config write fail	Config write failed at LBA <address>-<address> of PD <slot>.
ERROR	CV boot error adjust global	Failed to change size of the global cache.
INFO	CV boot global	The global cache is ok.
ERROR	CV boot error create global	Failed to create the global cache.
INFO	PD dedicated spare	Assign PD <slot> to be the dedicated spare disk of RG <name>.
INFO	PD global spare	Assign PD <slot> to Global Spare Disks.
WARNING	PD read error	Read error occurred at LBA <address>-<address> of PD <slot>.
WARNING	PD write error	Write error occurred at LBA <address>-<address> of PD <slot>.
WARNING	Scrub wrong parity	The parity/data inconsistency is found at LBA <address>-<address> when checking parity on VD <name>.
WARNING	Scrub data recovered	The data at LBA <address>-<address> is recovered when checking parity on VD <name>.
WARNING	Scrub recovered data	A recoverable read error occurred at LBA <address>-<address> when checking parity on VD <name>.
WARNING	Scrub parity recovered	The parity at LBA <address>-<address> is regenerated when checking parity on VD <name>.
INFO	PD freed	PD <slot> has been freed from RG <name>.
INFO	RG imported	Configuration of RG <name> has been imported.
INFO	RG restored	Configuration of RG <name> has been restored.
INFO	VD restored	Configuration of VD <name> has been restored.
INFO	PD scrub started	PD <slot> starts disk scrubbing process.
INFO	Disk scrub finished	PD <slot> completed disk scrubbing process.
INFO	Large RG created	A large RG <name> with <number> disks included is created
INFO	Weak RG created	A RG <name> made up disks across <number> chassis is created
INFO	RG size shrunk	The total size of RG <name> shrunk
INFO	VD erase finished	VD <name> finished erasing process.
WARNING	VD erase failed	The erasing process of VD <name> failed.

INFO	VD erase started	VD <name> starts erasing process.
-------------	------------------	-----------------------------------

- **Snapshot events**

Level	Type	Description
WARNING	Snap mem	Failed to allocate snapshot memory for VD <name>.
WARNING	Snap space overflow	Failed to allocate snapshot space for VD <name>.
WARNING	Snap threshold	The snapshot space threshold of VD <name> has been reached.
INFO	Snap delete	The snapshot VD <name> has been deleted.
INFO	Snap auto delete	The oldest snapshot VD <name> has been deleted to obtain extra snapshot space.
INFO	Snap take	A snapshot on VD <name> has been taken.
INFO	Snap set space	Set the snapshot space of VD <name> to <number> MB.
INFO	Snap rollback started	Snapshot rollback of VD <name> has been started.
INFO	Snap rollback finished	Snapshot rollback of VD <name> has been finished.
WARNING	Snap quota reached	The quota assigned to snapshot <name> is reached.
INFO	Snap clear space	The snapshot space of VD <name> is cleared

- **iSCSI events**

Level	Type	Description
INFO	iSCSI login accepted	iSCSI login from <IP> succeeds.
INFO	iSCSI login rejected	iSCSI login from <IP> was rejected, reason [<string>]
INFO	iSCSI logout recvd	iSCSI logout from <IP> was received, reason [<string>].

- **Battery backup events**

Level	Type	Description
INFO	BBM start syncing	Abnormal shutdown detected, start flushing battery-backed data (<number> KB).
INFO	BBM stop syncing	Abnormal shutdown detected, flushing battery-backed data finished
INFO	BBM installed	Battery backup module is detected
INFO	BBM status good	Battery backup module is good
INFO	BBM status charging	Battery backup module is charging
WARNING	BBM status fail	Battery backup module is failed
INFO	BBM enabled	Battery backup feature is <string>.
INFO	BBM inserted	Battery backup module is inserted
INFO	BBM removed	Battery backup module is removed

- **JBOD events**

Level	Type	Description

INFO	PD upgrade started	JBOD <name> PD [<string>] starts upgrading firmware process.
INFO	PD upgrade finished	JBOD <name> PD [<string>] finished upgrading firmware process.
WARNING	PD upgrade failed	JBOD <name> PD [<string>] upgrade firmware failed.
INFO	PD freed	JBOD <name> PD <slot> has been freed from RG <name>.
INFO	PD inserted	JBOD <name> disk <slot> is inserted into system.
Warning	PD removed	JBOD <name> disk <slot> is removed from system.
ERROR	HDD read error	JBOD <name> disk <slot> read block error
ERROR	HDD write error	JBOD <name> disk <slot> write block error
ERROR	HDD error	JBOD <name> disk <slot> is disabled.
ERROR	HDD IO timeout	JBOD <name> disk <slot> gets no response
INFO	JBOD inserted	JBOD <name> is inserted into system
WARNING	JBOD removed	JBOD <name> is removed from system
WARNING	SMART T.E.C	JBOD <name> disk <slot>: S.M.A.R.T. Threshold Exceed Condition occurred for attribute <string>
WARNING	SMART fail	JBOD <name> disk <slot>: Failure to get S.M.A.R.T information
INFO	PD dedicated spare	Assign JBOD <name> PD <slot> to be the dedicated spare disk of RG <name>.
INFO	PD global spare	Assign JBOD <name> PD <slot> to Global Spare Disks.
ERROR	Config read fail	Config read error occurred at LBA <address>-<address> of JBOD <name> PD <slot>.
ERROR	Config write fail	Config write error occurred at LBA <address>-<address> of JBOD <name> PD <slot>.
WARNING	PD read error	Read error occurred at LBA <address>-<address> of JBOD <name> PD <slot>.
WARNING	PD write error	Write error occurred at LBA <address>-<address> of JBOD <name> PD <slot>.
INFO	PD scrub started	JBOD <name> PD <slot> starts disk scrubbing process.
INFO	PD scrub completed	JBOD <name> PD <slot> completed disk scrubbing process.
WARNING	PS fail	Power Supply of <string> in JBOD <name> is FAIL
INFO	PS normal	Power Supply of <string> in JBOD <name> is NORMAL
WARNING	FAN fail	Cooling fan of <string> in JBOD <name> is FAIL
INFO	FAN normal	Cooling fan of <string> in JBOD <name> is NORMAL
WARNING	Volt warn OV	Voltage of <string> read as <string> in JBOD <name> is WARN OVER
WARNING	Volt warn UV	Voltage of <string> read as <string> in JBOD <name> is WARN UNDER
WARNING	Volt crit OV	Voltage of <string> read as <string> in JBOD <name> is CRIT OVER
WARNING	Volt crit UV	Voltage of <item> read as <string> in JBOD <name> is CRIT UNDER
INFO	Volt recovery	Voltage of <string> in JBOD <string> is NORMAL
WARNING	Therm warn OT	Temperature of <string> read as <string> in JBOD <name> is OT WARNING
WARNING	Therm warn UT	Temperature of <string> read as <string> in JBOD <name> is UT WARNING
WARNING	Therm fail OT	Temperature of <string> read as <string> in JBOD <name> is OT FAILURE
WARNING	Therm fail UT	Temperature of <string> read as <string> in JBOD <name> is UT FAILURE
INFO	Therm recovery	Temperature of <string> in JBOD <name> is NORMAL

- **System maintenance events**

Level	Type	Description
INFO	System shutdown	System shutdown.
INFO	System reboot	System reboot.
INFO	System console shutdown	System shutdown from <string> via Console UI
INFO	System web shutdown	System shutdown from <string> via Web UI
INFO	System button shutdown	System shutdown via power button
INFO	System LCM shutdown	System shutdown via LCM
INFO	System console reboot	System reboot from <string> via Console UI
INFO	System web reboot	System reboot from <string> via Web UI
INFO	System LCM reboot	System reboot via LCM
INFO	FW upgrade start	System firmware upgrade starts.
INFO	FW upgrade success	System firmware upgrade succeeds.
WARNING	FW upgrade failure	System firmware upgrade is failed.
ERROR	IPC FW upgrade timeout	System firmware upgrade timeout on another controller
INFO	Config imported	<string> config imported

- **HAC events**

Level	Type	Description
INFO	RG owner changed	The preferred owner of RG <name> has been changed to controller <number>.
INFO	Force CTR write through	Controller <number> forced to adopt write-through mode on failover.
INFO	Restore CTR cache mode	Controller <number> restored to previous caching mode on failback.
INFO	Failover complete	All volumes in controller <number> completed failover process.
INFO	Failback complete	All volumes in controller <number> completed failback process.
INFO	CTR inserted	Controller <number> is inserted into system
ERROR	CTR removed	Controller <number> is removed from system
ERROR	CTR timeout	Controller <number> gets no response
ERROR	CTR lockdown	Controller <number> is locked down
ERROR	CTR memory NG	Memory size mismatch
ERROR	CTR firmware NG	Firmware version mismatch
ERROR	CTR lowspeed NG	Low speed inter link is down
ERROR	CTR highspeed NG	High speed inter link is down
ERROR	CTR backend NG	SAS expander is down
ERROR	CTR frontend NG	FC IO controller is down
INFO	CTR reboot FW sync	Controller reboot, reason [Firmware synchronization completed]

- **Clone events**

Level	Type	Description
INFO	VD clone started	VD <name> starts cloning process.
INFO	VD clone finished	VD <name> finished cloning process.
WARNING	VD clone failed	The cloning in VD <name> failed.
INFO	VD clone aborted	The cloning in VD <name> was aborted.
INFO	VD clone set	The clone of VD <name> has been designated.
INFO	VD clone reset	The clone of VD <name> is no longer designated.
WARNING	Auto clone error	Auto clone task: <string>.
WARNING	Auto clone no snap	Auto clone task: Snapshot <name> is not found for VD <name>.

A. Certification list

- RAM

RSF362 RAM Spec: 240-pin, DDR2-533(PC4300), Reg.(register) or UB(Unbuffered), ECC, up to 4GB, 64-bit data bus width (and also 32-bit memory), x8 or x16 devices, 36-bit addressable, up to 14-bit row address and 10-bit column address.

Vendor	Model
ATP	AJ64K72F8BHE6S, 512MB DDR2-667 (Unbuffered, ECC) with SEC
ATP	AJ28K64E8BHE6S, 1GB DDR2-667 (Unbuffered, non-ECC) with SEC
ATP	AJ28K72G8BHE6S, 1GB DDR2-667 (Unbuffered, ECC) with SEC
ATP	AJ56K72G8BJE6S, 2GB DDR2-667 (Unbuffered, ECC) with Samsung
Kingston	KVR667D2E5/1G, 1GB DDR2-667 (Unbuffered, ECC) with Hynix
Kingston	KVR800D2E6/1G, 1GB DDR2 800 (Unbuffered, ECC) with Hynix
Kingston	KVR667D2E5/2G, 2GB DDR2-667 (Unbuffered, ECC) with Hynix
Kingston	KVR800D2E6/2G, 2GB DDR2-800 (Unbuffered, ECC) with ELPIDA
Unigen	UG12T7200L8DU-5AM, 1GB DDR2-533 (Unbuffered, ECC) with Elpida
Unigen	UG12T7200L8DR-5AC, 1GB DDR2-533 (Registered, ECC) with Elpida
Unigen	UG12T7200M8DU-5AL, 1GB DDR2-533 (Unbuffered, ECC) with Hynix
Unigen	UG12T7200L8DU-5AM, 1GB DDR2-533 (Unbuffered, ECC) with Hynix
Unigen	UG25T7200M8DU-5AM, 2GB DDR2-533 (Unbuffered, ECC) with Micron
Unigen	UG64T7200L8DU-6AL, 512MB DDR2-667 (Unbuffered, ECC) with Elpida
Unigen	UG12T7200L8DU-6AM, 1GB DDR2-667 (Unbuffered, ECC) with Hynix
Unigen	UG12T7200M8DU-6AK, 1GB DDR2-667 (Unbuffered, ECC, Low profile) with Hynix
Unigen	UG25T7200M8DU-6AMe, 2GB DDR2-667 (Unbuffered, ECC) with Hynix
Unigen	UG25T7200M8DU-6AK, 2GB DDR2-667 (Unbuffered, ECC, Low profile) with Hynix

- FC HBA card

Vendor	Model
Brocade	410 (PCI-Express, 2.5 GHz, 4 Gb/s, 1 port, LC style pluggable SFP, multimode optics 850nm) + Finisar FTLF 8524P2BNL
LSI Logic	LSI7204XP-LC (PCI-X, 4 Gb/s, 2 ports, LC style pluggable SFP, multimode optics 850nm) + Picolight PLRXPL-VE-SG4-26
LSI Logic	LSI7104EP-LC (PCI-Express, 4 Gb/s, 1 ports, LC style pluggable SFP, multimode optics 850nm) + Finisar FTLF8524P2BNL
LSI Logic	LSI7204EP-LC (PCI-Express, 4 Gb/s, 2 ports, LC style pluggable SFP, multimode optics 850nm) + Finisar FTLF8524P2BNL
QLogic	QLA2462 (PCI-X 2.0, 266MHz, 4 Gb/s, 2 ports, LC style SFF, multimode optics 850nm) + Finisar FTLF 8524E2KNL
QLogic	QLE2462 (PCI-Express, 2.5 GHz, 4 Gb/s, 2 ports, LC style SFF, multimode optics 850nm) + Finisar FTLF 8524E2KNL

- FC GBIC

Vendor	Model

Avago	AFBR-57R5APZ (4.25 Gb/s SFP transceiver, 850nm)
Finisar	FTLF 8524P2BNL (4.25 Gb/s SFP transceiver, 850nm)
JDSU	JSH-42S4DB3 (4.25Gb/s SFP transceiver, 850nm)
Picolight	PLRXPL-VE-SG4-26 (4.25Gb/s SFP transceiver, 850nm)

- **FC Switch**

Vendor	Model
Brocade	BR-200E

- **Hard drive**

SAS 3.5"

Vendor	Model
Hitachi	Ultrastar 15K147, HUS151436VLS300, 36GB, 15000RPM, SAS 3.0Gb/s, 16M
Hitachi	Ultrastar 15K300, HUS153073VLS300, 73GB, 15000RPM, SAS 3.0Gb/s, 16M (F/W: A410)
Seagate	Cheetah 15K.4, ST336754SS, 36.7GB, 15000RPM, SAS 3.0Gb/s, 8M
Seagate	Cheetah 15K.5, ST373455SS, 73.4GB, 15000RPM, SAS 3.0Gb/s, 16M
Seagate	Cheetah 15K.5, ST3146855SS, 146.8GB, 15000RPM, SAS 3.0Gb/s, 16M
Seagate	Cheetah 15K.6, ST3450856SS, 450GB, 15000RPM, SAS 3.0Gb/s, 16M (F/W: 003)
Seagate	Cheetah NS, ST3400755SS, 400GB, 10000RPM, SAS 3.0Gb/s, 16M
Seagate	Barracuda ES.2, ST31000640SS, 1TB, 7200RPM, SAS 3.0Gb/s, 16M (F/W: 0002)
Seagate	Cheetah NS.2, ST3600002SS, 600GB, 10000RPM, SAS 2.0, 6.0Gb/s, 16M (F/W: 0004)
Seagate	Cheetah 15K.7, ST3600057SS, 600GB, 15000RPM, SAS 2.0, 6.0Gb/s, 16MB (F/W: 0004)
Seagate	Constellation ES, ST31000424SS, 1TB, 7200RPM, SAS 2.0 6.0Gb/s, 16MB (F/W: 0005)
Seagate	Constellation ES, ST32000444SS, 2TB, 7200RPM, SAS 2.0 6.0Gb/s, 16MB (F/W: 0005)

SAS 2.5"

Vendor	Model
Seagate	Savvio 10K.3, ST9300603SS, 300GB, 10000RPM, SAS 2.0, 6.0Gb/s, 16M (F/W: 0003)
Seagate	Savvio 15K.2, ST9146852SS, 147GB, 15000RPM, SAS 2.0, 6.0Gb/s, 16M (F/W: 0002)
Seagate	Constellation, ST9500430SS, 500GB, 7200RPM, SAS 2.0, 6.0Gb/s, 16M (F/W: 0001)

SATA 3.5"

Vendor	Model
Hitachi	Deskstar 7K250, HDS722580VLSA80, 80GB, 7200RPM, SATA, 8M
Hitachi	Deskstar E7K500, HDS725050KLA360, 500GB, 7200RPM, SATA II, 16M

Hitachi	Deskstar 7K80, HDS728040PLA320, 40GB, 7200RPM, SATA II, 2M
Hitachi	Deskstar T7K500, HDT725032VLA360, 320GB, 7200RPM, SATA II, 16M
Hitachi	Deskstar P7K500, HDP725050GLA360, 500GB, 7200RPM, SATA II, 16M (F/W: K2A0AD1A)
Hitachi	Deskstar E7K1000, HDE721010SLA330, 1TB, 7200RPM, SATA 3.0Gb/s, 32MB, NCQ (F/W: ST60A3AA)
Hitachi	UltraStar A7K2000, HUA722020ALA330, 2TB, 7200RPM, SATA 3.0Gb/s, 32MB, NCQ (F/W: JKAOA20N)
Maxtor	DiamondMax Plus 9, 6Y080M0, 80GB, 7200RPM, SATA, 8M
Maxtor	DiamondMax 11, 6H500F0, 500GB, 7200RPM, SATA 3.0Gb/s, 16M
Samsung	SpinPoint P80, HDSASP0812C, 80GB, 7200RPM, SATA, 8M
Seagate	Barracuda 7200.7, ST380013AS, 80GB, 7200RPM, SATA 1.5Gb/s, 8M
Seagate	Barracuda 7200.7, ST380817AS, 80GB, 7200RPM, SATA 1.5Gb/s, 8M, NCQ
Seagate	Barracuda 7200.8, ST3400832AS, 400GB, 7200RPM, SATA 1.5Gb/s, 8M, NCQ
Seagate	Barracuda 7200.9, ST3500641AS, 500GB, 7200RPM, SATA 3.0Gb/s, 16M, NCQ
Seagate	Barracuda 7200.11, ST3500320AS, 500GB, 7200RPM, SATA 3.0Gb/s, 32M, NCQ
Seagate	Barracuda 7200.11, ST31000340AS, 1TB, 7200RPM, SATA 3.0Gb/s, 32M, NCQ
Seagate	Barracuda 7200.11, ST31500341AS, 1.5TB, 7200RPM, SATA 3.0Gb/s, 32M, NCQ (F/W: SD17)
Seagate	NL35.2, ST3400633NS, 400GB, 7200RPM, SATA 3.0Gb/s, 16M
Seagate	NL35.2, ST3500641NS, 500GB, 7200RPM, SATA 3.0Gb/s, 16M
Seagate	Barracuda ES, ST3500630NS, 500GB, 7200RPM, SATA 3.0Gb/s, 16M
Seagate	Barracuda ES, ST3750640NS, 750GB, 7200RPM, SATA 3.0Gb/s, 16M
Seagate	Barracuda ES.2, ST31000340NS, 1TB, 7200RPM, SATA 3.0Gb/s, 32M (F/W: SN06)
Seagate	SV35.5, ST3500410SV, 500GB, 7200 RPM, SATA 3.0Gb/s, 16M, NCQ (F/W: CV11)
Seagate	Constellation ES, ST31000524NS, 1TB, 7200RPM, SATA 3.0Gb/s, 32M, NCQ (F/W: SN11)
Western Digital	Caviar SE, WD800JD, 80GB, 7200RPM, SATA 3.0Gb/s, 8M
Western Digital	Caviar SE, WD1600JD, 160GB, 7200RPM, SATA 1.5Gb/s, 8M
Western Digital	Caviar RE2, WD4000YR, 400GB, 7200RPM, SATA 1.5Gb/s, 16M, NCQ
Western Digital	Caviar RE16, WD5000AAKS, 500GB, 7200RPM, SATA 3.0Gb/s, 16M
Western Digital	RE2, WD4000YS, 400GB, 7200RPM, SATA 3.0Gb/s, 16M
Western Digital	RE2, WD5000ABYS, 500GB, 7200RPM, SATA 3.0Gb/s, 16M, NCQ
Western Digital	RE2-GP, WD1000FYPS, 1TB, 7200RPM, SATA 3.0Gb/s, 16M
Western Digital	RE3, WD1002FBYS, 1000GB, 7200RPM, SATA 3.0Gb/s, 32M, NCQ (F/W: 03.00C05)
Western Digital	RE4, WD2002FYPS, 2TB, IntelliPower, SATA 3.0Gb/s, 64M, NCQ (F/W: 04.05G04)
Western Digital	RE4-GP, WD2002FYPS, 2TB, IntelliPower, SATA 3.0Gb/s, 64M, NCQ (F/W: 04.01G01)
Western Digital	RE4, WD2003FYYS, 2TB, 7200RPM, SATA 3.0Gb/s, 64M, NCQ (F/W: 01.01D01)
Western Digital	RE4, WD1003FBYX, 1TB, 7200RPM, SATA 3.0Gb/s, 64M, NCQ (F/W: 01.01V01)
Western Digital	RE4, WD5003ABYX, 500GB, 7200RPM, SATA 3.0Gb/s, 64M, NCQ (F/W: 01.01S01)
Western Digital	Raptor, WD360GD, 36.7GB, 10000RPM, SATA 1.5Gb/s, 8M
Western Digital	VelcoiRaptor, WD3000HLFS, 300GB, 10000RPM, SATA 3.0Gb/s, 16M (F/W: 04.04V01)

SATA 2.5"

Vendor	Model
Seagate	Constellation, ST9500530NS, 500GB, 7200RPM, SATA 3.0Gb/s, 32M (F/W: SN02)

System information

SW version	1.0.8p2
-------------------	---------