



Synergy Global Technology Inc

www.RackmountMart.com

Toll Free: 1-888-865-6888

Tel: 510-226-8368 Fax: 510-226-8968

Email: sales@RackmountMart.com

User Manual 21.5" Full HD LCD

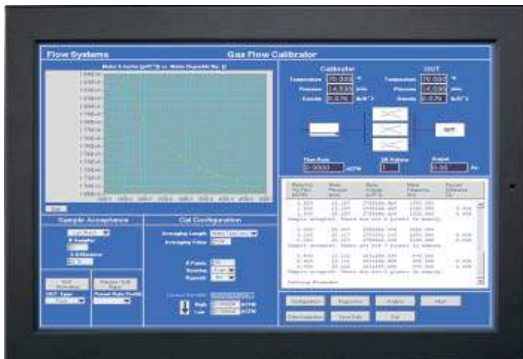

ID-E21Aw

Aluminum front bezel

ID-E21AwN

Front NEMA4 / IP65



ID-E21Pw & ID-2-E21Pw

Universal Mounting Open Frame

FC CE

Legal Information

First English printing, October 2002

Information in this document has been carefully checked for accuracy; however, no guarantee is given to the correctness of the contents. The information in this document is subject to change without notice. We are not liable for any injury or loss that results from the use of this equipment.

Safety Instructions

Please read all of these instructions carefully before you use the device. Save this manual for future reference.

- Unplug equipment before cleaning. Don't use liquid or spray detergent; use a moist cloth.
- Keep equipment away from excessive humidity and heat. Preferably, keep it in an air-conditioned environment with temperatures not exceeding 40° Celsius (104° Fahrenheit).
- When installing, place the equipment on a sturdy, level surface to prevent it from accidentally falling and causing damage to other equipment or injury to persons nearby.
- When the equipment is in an open position, do not cover, block or in any way obstruct the gap between it and the power supply. Proper air convection is necessary to keep it from overheating.
- Arrange the equipment's power cord in such a way that others won't trip or fall over it.
- If you are using a power cord that didn't ship with the equipment, ensure that it is rated for the voltage and current labeled on the equipment's electrical ratings label. The voltage rating on the cord should be higher than the one listed on the equipment's ratings label.
- Observe all precautions and warnings attached to the equipment.
- If you don't intend on using the equipment for a long time, disconnect it from the power outlet to prevent being damaged by transient over-voltage.
- Keep all liquids away from the equipment to minimize the risk of accidental spillage. Liquid spilled on to the power supply or on other hardware may cause damage, fire or electrical shock.
- Only qualified service personnel should open the chassis. Opening it yourself could damage the equipment and invalidate its warranty.
- If any part of the equipment becomes damaged or stops functioning, have it checked by qualified service personnel.

What the warranty does not cover

- Any product, on which the serial number has been defaced, modified or removed.
- Damage, deterioration or malfunction resulting from:
 - Accident, misuse, neglect, fire, water, lightning, or other acts of nature, unauthorized product modification, or failure to follow instructions supplied with the product.
 - Repair or attempted repair by anyone not authorized by us.
 - Any damage of the product due to shipment.
 - Removal or installation of the product.
 - Causes external to the product, such as electric power fluctuation or failure.
 - Use of supplies or parts not meeting our specifications.
 - Normal wear and tear.
 - Any other causes which does not relate to a product defect.
- Removal, installation, and set-up service charges.

Regulatory Notices Federal Communications Commission (FCC)

This equipment has been tested and found to comply with the limits for a Class B digital device, pursuant to Part 15 of the FCC rules. These limits are designed to provide reasonable protection against harmful interference in a residential installation.

Any changes or modifications made to this equipment may void the user's authority to operate this equipment. This equipment generates, uses, and can radiate radio frequency energy and, if not installed and used in accordance with the instructions, may cause harmful interference to radio communications.

However, there is no guarantee that interference will not occur in a particular installation. If this equipment does cause harmful interference to radio or television reception, which can be determined by turning the equipment off and on, the user is encouraged to try to correct the interference by one or more of the following measures:

- Re-position or relocate the receiving antenna.
- Increase the separation between the equipment and receiver.
- Connect the equipment into an outlet on a circuit different from that to which the receiver is connected.

Contents

< Part. 1 > ID-E21Aw / ID-E21AwN

1.1	Package Content	P.1
1.2	Structure Diagram & Dimension	P.2 - 3
1.3	Mounting Hardware & Installation	P.4 - 5

< Part. 2 > ID-E21Pw

2.1	Package Content	P.6
2.2	Structure Diagram & Dimension	P.7 - 8
2.3	Mounting Hardware & Installation	P.9

< Part. 3 > Specifications / LCD OSD

3.1	Product Specifications	P.10 - 11
3.2	OSD for Basic Inputs (VGA + DVI-D)	P.12
	OSD for Upgrade Inputs (VGA, DVI-D, HDMI, AV, Audio)	P.13 - 14

< Part. 4 > Options

4.1	Option Table	P.15
4.2	3G / HD / SD- SDI Broadcast-grade input	P.16
4.3	MC Multi-display control solution	P.17 - 18
4.4	21.5" Touchscreen : Resistive, Capacitive, Multi-touch	P.19 - 20
4.5	48V, 24V or 12VDC power	P.20
4.6	MIL-type or lockable connector	P.21
4.7	Quad display for CCTV	P.22
4.8	TV - PAL or NTSC	P.23 - 24

Before Installation

- It is very important to mount the equipment in a suitable cabinet or on a stable surface.
- Make sure the place has a good ventilation, is out of direct sunlight, away from sources of excessive dust, dirt, heat, water, moisture and vibration.

Unpacking

The equipment comes with the standard parts shown in package content. Check and make sure they are included and in good condition. If anything is missing, or damaged, contact the supplier immediately.

How To Clean Your LCD Monitor



Caution :

- To avoid the risk of electric shock, make sure your hands are dry before unplugging your monitor from or plugging your monitor into an electrical outlet.
- When you clean your monitor, do not press down on the LCD screen. Pressing down on the screen can scratch or damage your display. Pressure damage is not covered under warranty.
- Use only cleansers made specifically for cleaning monitors and monitor screens. Cleansers not made to clean monitors and monitor screens can scratch the LCD display or strip off the finish.
- Do not spray any kind of liquid directly onto the screen or case of your monitor. Spraying liquids directly onto the screen or case can cause damage which is not covered under warranty.
- Do not use paper towels or abrasive pads to clean your monitor. Using an abrasive pad or any wood based paper product such as paper towels can scratch your LCD screen.

Cleaning Your Monitor

To clean your LCD safely, please follow these steps :

- ① Disconnect the power cord.
- ② Gently wipe the surface using a clean, dry microfiber cloth. Use as little pressure as possible.

Cleaning Tough Marks and Smudges

To remove tough marks and smudges, please follow these steps :

- ① Disconnect the power cord.
- ② Spray a small amount of non-abrasive cleanser on a microfiber cloth.



Caution : Do not spray or apply any liquids directly onto the monitor. Always apply the solution to your microfiber cloth first, not directly on the parts you are cleaning.

- ③ Gently wipe the surface. Use as little pressure as possible.
- ④ Wait until your monitor is completely dry before plugging it in and powering it up.

< Part 1 >

< 1.1 > Package Content - ID-E21Aw / ID-E21AwN

ID-E21Aw / ID-E21AwN

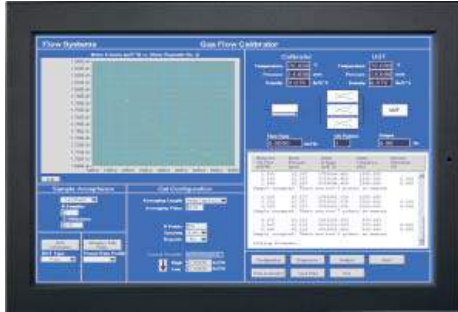

21.5" Full-HD LCD display X 1

6ft VGA cable X 1

Power adapter X 1

Power cord X 1

Mounting hardware X 1 pack

- Mounting bracket x 4 pcs

- M4* 6mm screw x 8 pcs

- M4* 50mm screw x 8 pcs

< 1.2 > Structure Diagram - ID-E21Aw / ID-E21AwN

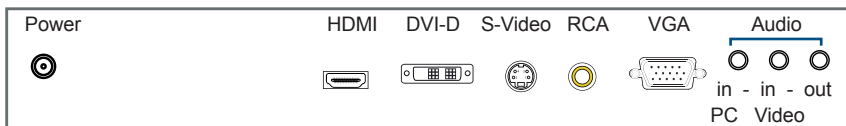
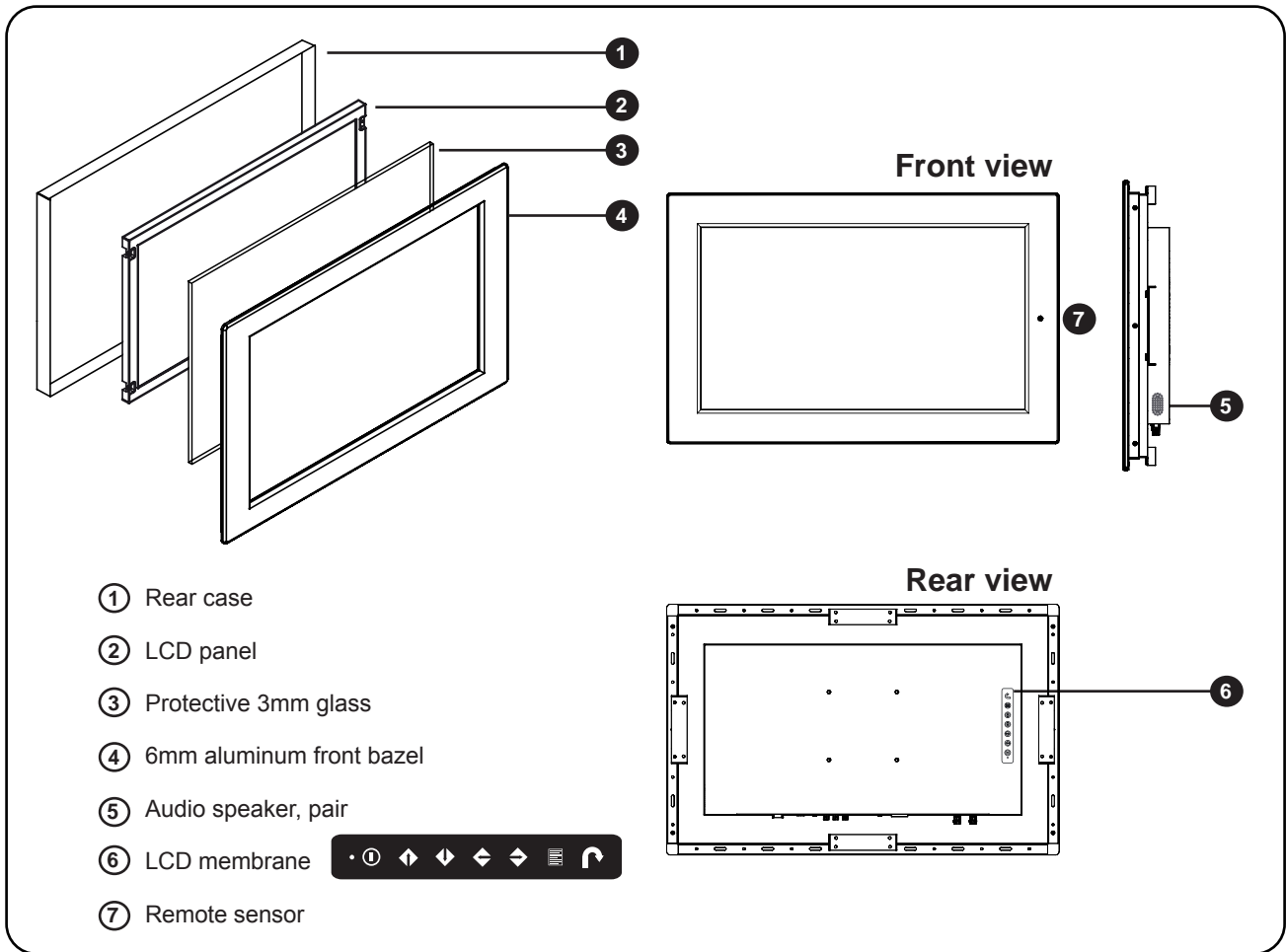

Standard I/O : VGA and DVI-D

Options I/O : HDMI, Audio, S-Video + RCA with remote controller
 TV, USB for touchscreen
 SDI or MC (either one)

Model	Product Dimension (W x D x H)	Net Weight
ID-E21Aw ID-E21AwN	578 x 59 x 369 mm 22.7 x 2.3 x 14.5 inch	5 kg 11 lbs

< 1.2 > Dimension - ID-E21Aw / ID-E21AwN

Front View

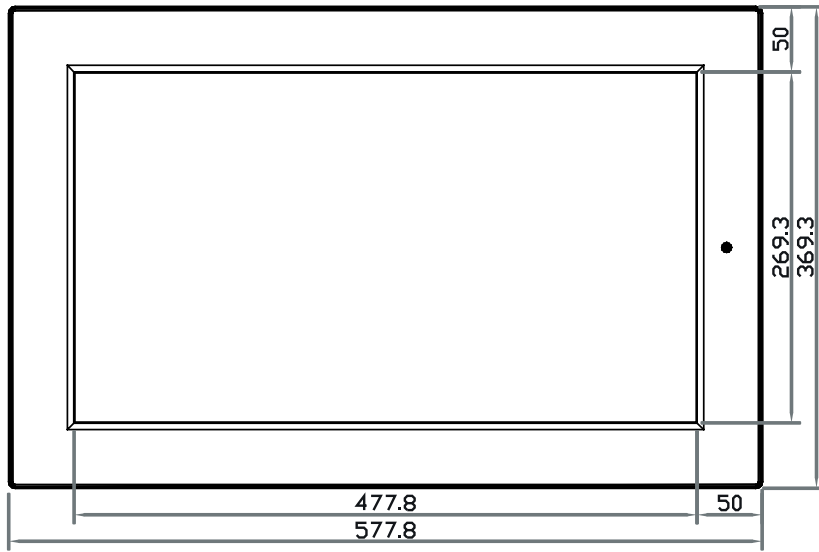

Side View

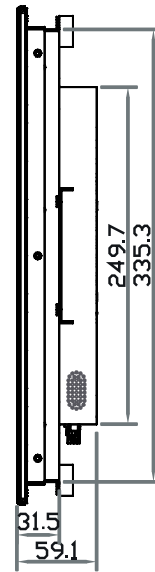

Rear View

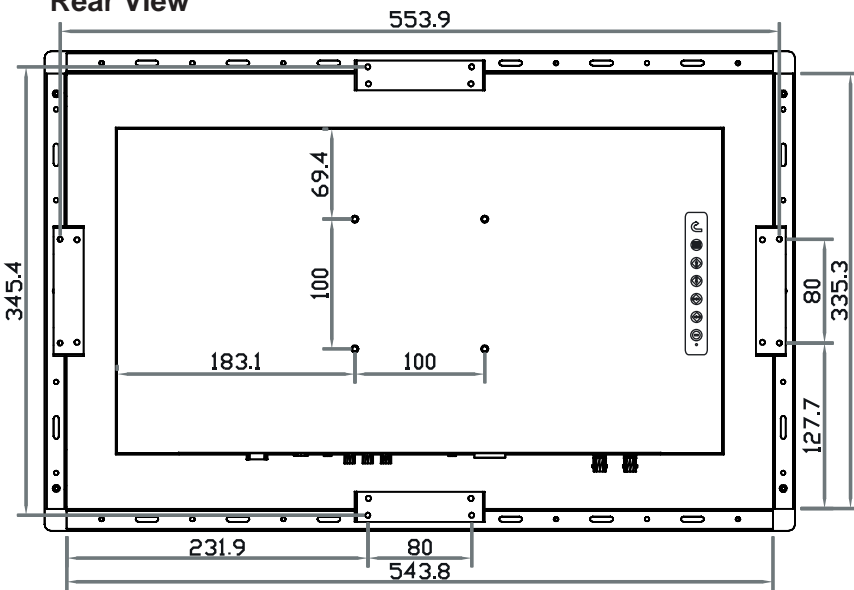

UNIT : mm
1mm = 0.03937 inch

Bottom View

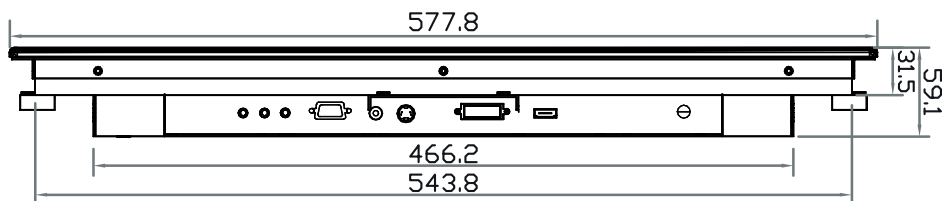

< 1.3 > Panel Mount Installation - ID-E21Aw / ID-E21AwN

- 1 Mounting bracket
x 4 pcs

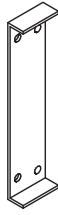

- 2 M4*6mm screw
x 8 pcs



- 3 M4*50mm screw
x 8 pcs

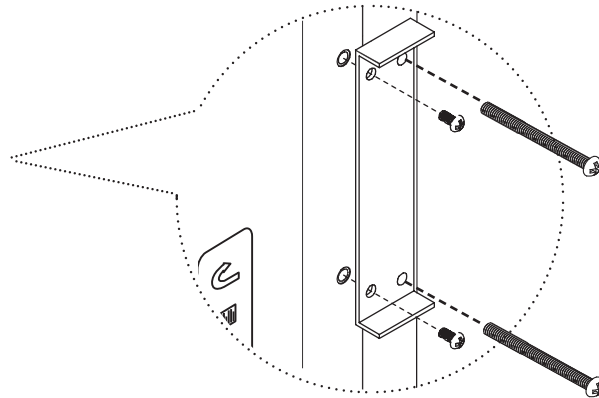
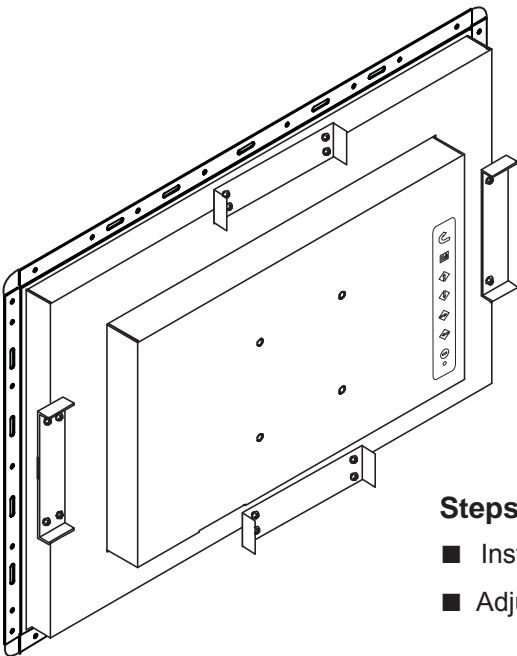
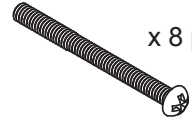

Steps

- Install 4 mounting brackets with 8 x M4*6mm screws
- Adjust the LCD panel with 8 x M4*50mm screws and fix it on the surface.

< 1.3 > VESA mount Installation - ID-E21Aw / ID-E21AwN

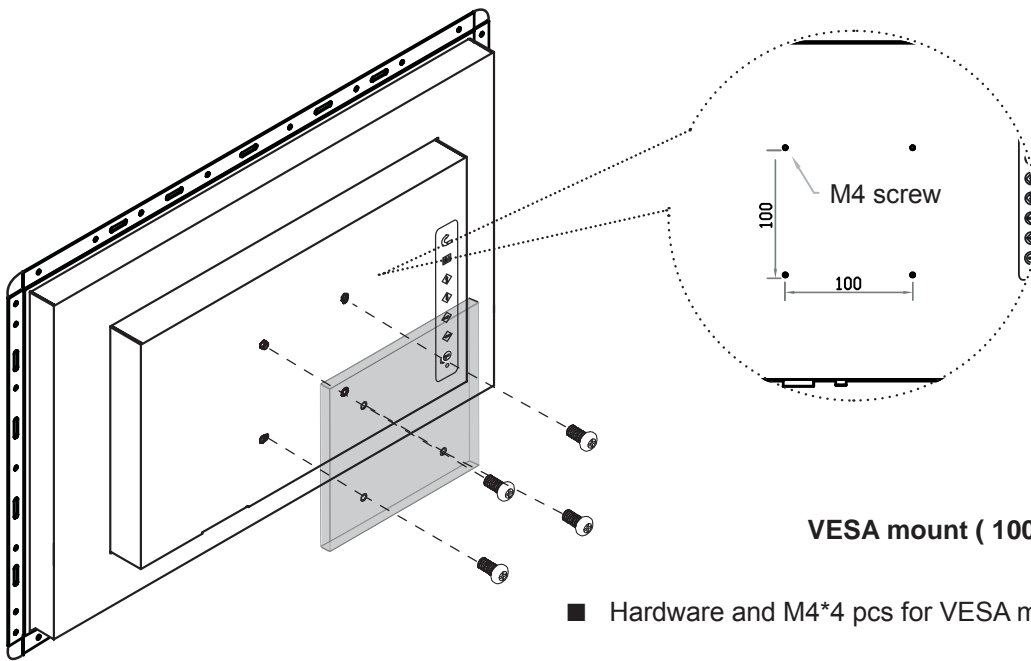

< Part 2 >

< 2.1 > Package Content - ID-E21Pw

ID-E21Pw

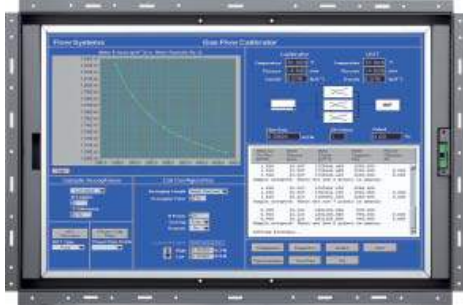

21.5" Full-HD LCD display X 1

6ft VGA cable X 1

Power adapter X 1

Power cord X 1

< 2.2 > Structure Diagram - ID-E21Pw

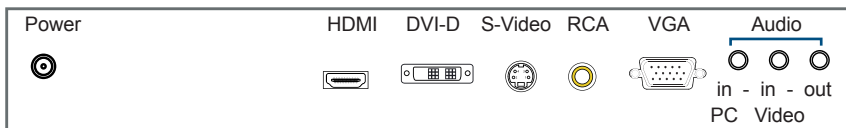
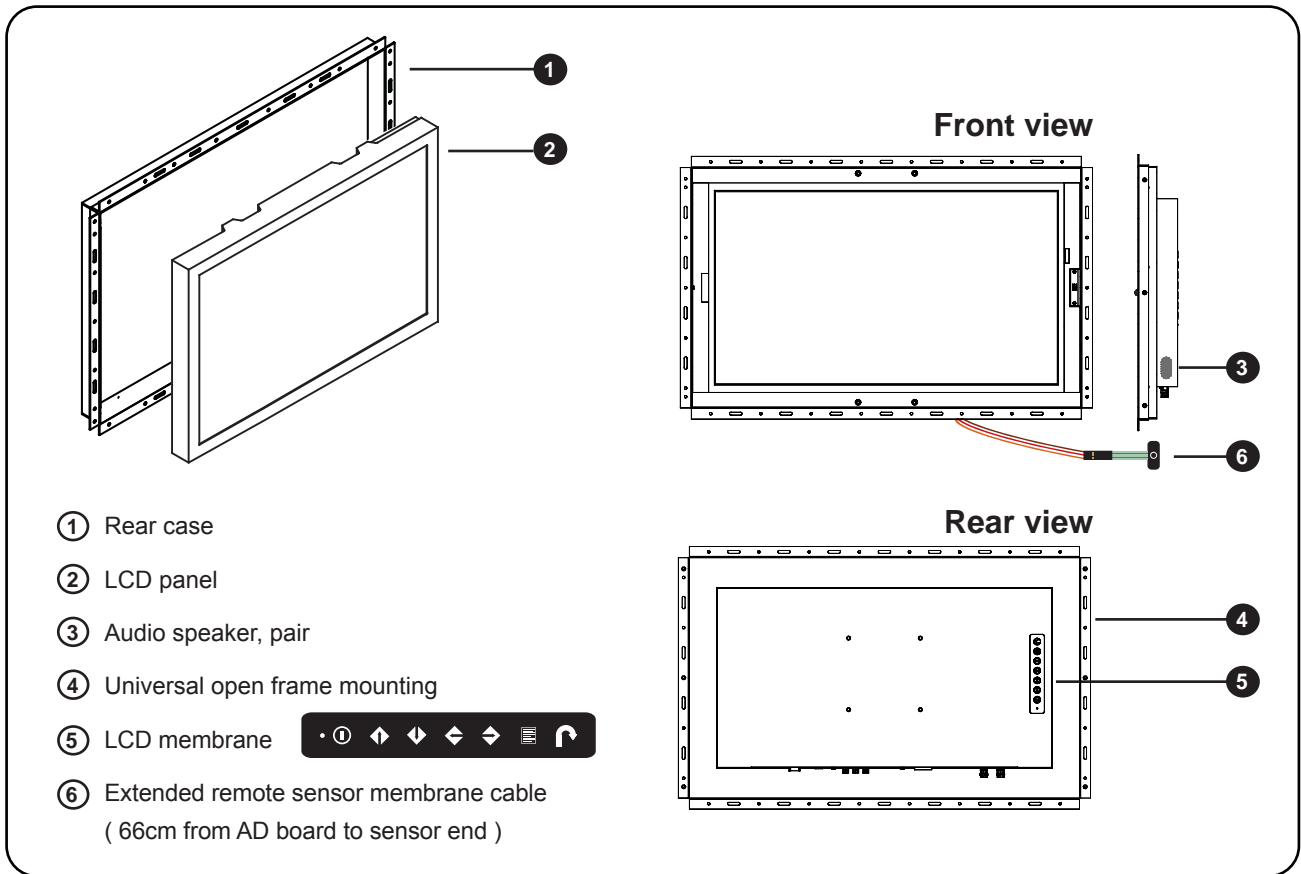

Standard I/O : VGA and DVI-D

Options I/O : HDMI, Audio, S-Video + RCA with remote controller
TV, USB for touchscreen
SDI or MC (either one)

Model	Product Dimension (W x D x H)	Net Weight
ID-E21Pw	575 x 53 x 366 mm 22.6 x 2.1 x 14.4 inch	5 kg 11 lbs

< 2.2 > Dimension - ID-E21Pw

Front View

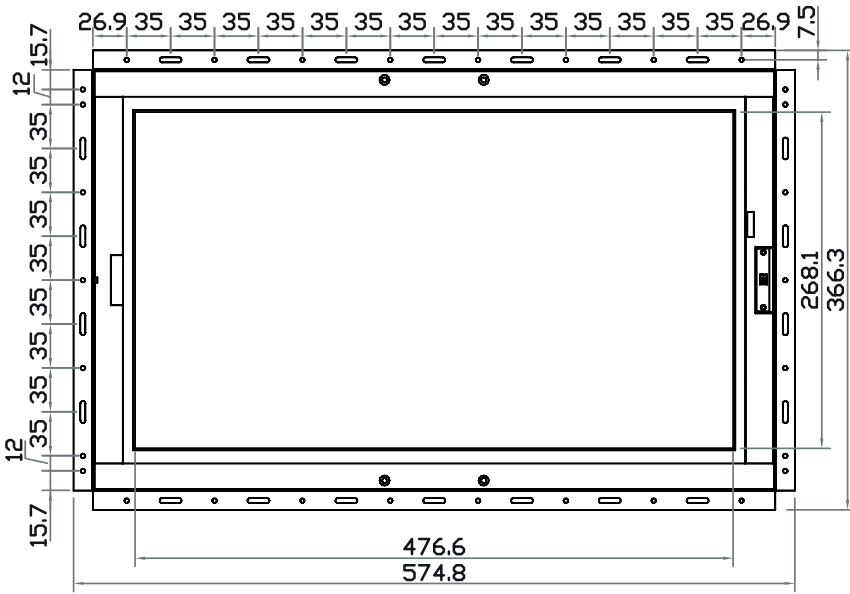

Side View

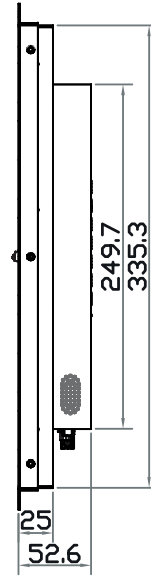

Rear View

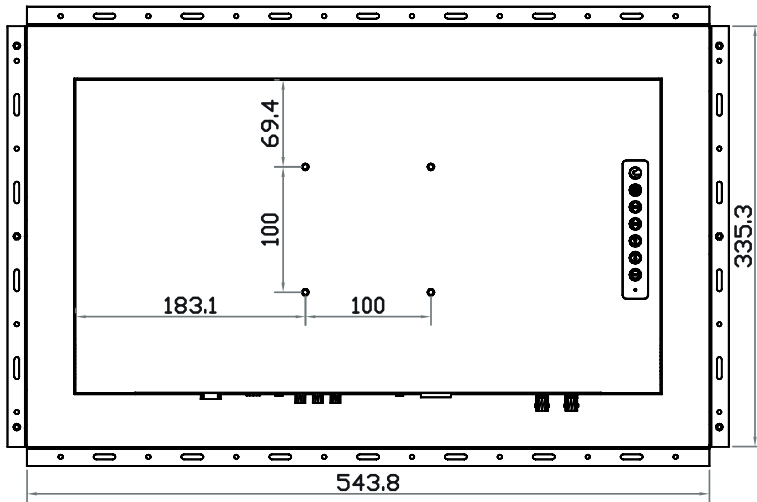

UNIT : mm
1mm = 0.03937 inch

Bottom View

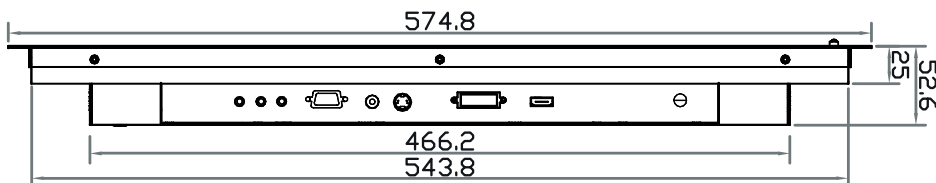

< 2.3 > Installation - ID-E21Pw

(I) Universal mount

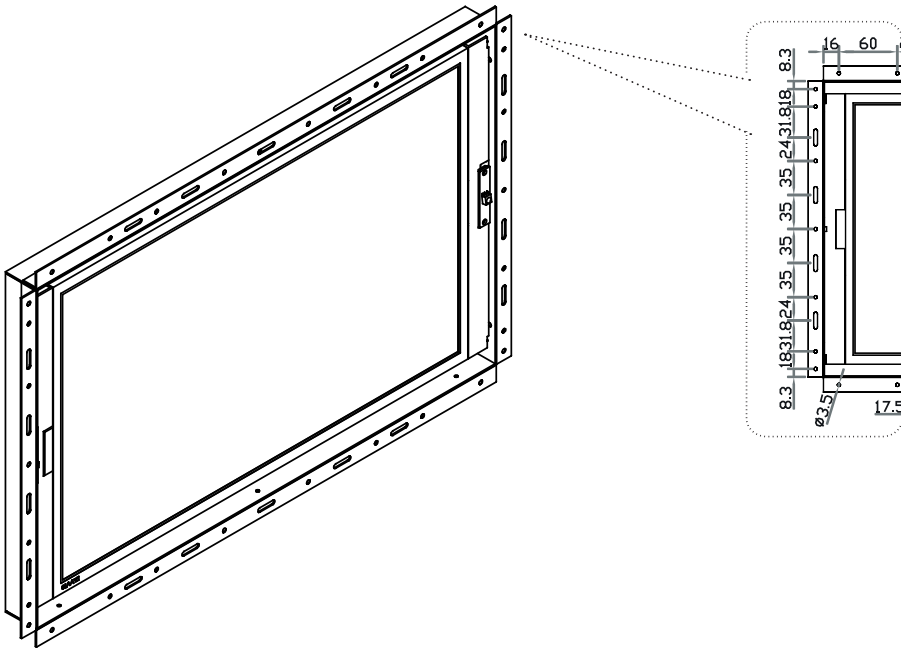

(II) VESA mount (100*100mm)

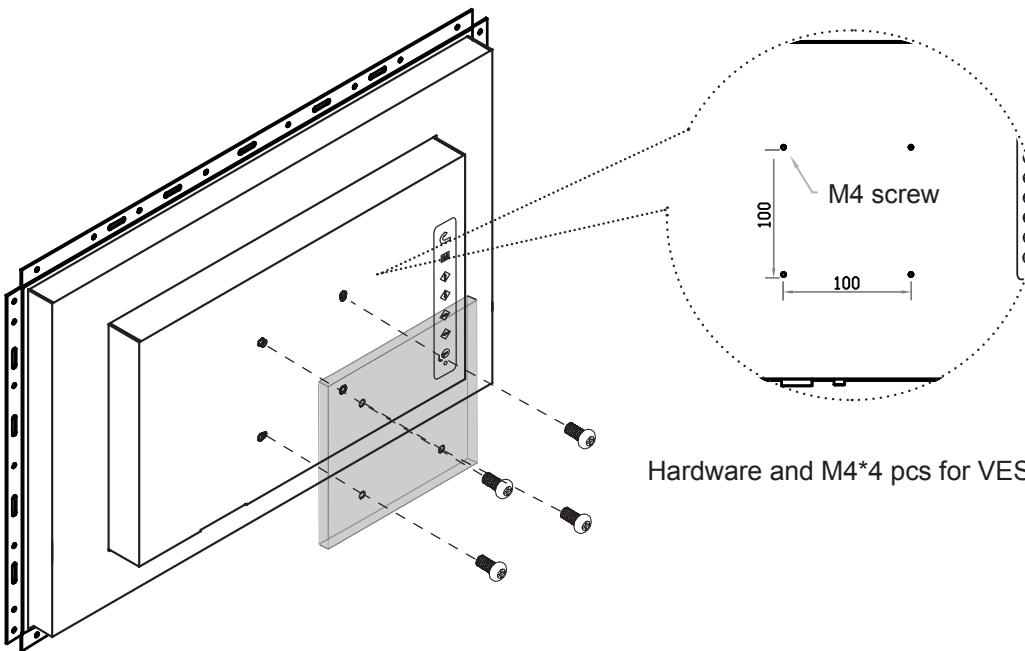

Hardware and M4*4 pcs for VESA mounting are not provided

< Part 3 >

< 3.1 > Product Specifications

Mechanical Design		ID-E21Aw/ID-E21AwN	ID-E21Pw
	Front Panel	Black, RAL 9005	-
	Rear Casing	Dark grey, RAL 7037	Dark grey, RAL 7037
	VESA Mounting	100 x 100mm	100 x 100mm
	Other Mounting	Panel mount	Universal mount
	Protection	3mm protective glass	

LCD Panel	Manufacturer		
	Panel Size (diagonal)	21.5-inch Widescreen TFT color LCD	
	Display pixel (dots x lines)	1920 x 1080	
	Brightness (typ.)	250	
	Contrast Ratio (typ.)	1000:1	
	Color	16.7 M	
	Viewing Angle (L/R/U/D)	85/85/80/80	
	Response Time (ms)	5	
	Dot pitch (mm)	0.248	
	Display Area (mm)	476.64H x 268.11V	
	Surface treatment	Haze 25%, Hard-coating	
	Surface hardness	3H	
	Backlight Type	LED	
	MTBF (hrs)	30,000	

Video Connectivity	Digital	HDMI	HDMI 1.1, CEA-861-D
		DVI	DVI-D, TMDS single link
	Analog	VGA	Analog 0.7Vp-p
		Composite (RCA)	NTSC & PAL
		S-Video (4-pin)	NTSC & PAL
	Plug & Play	DVI / VGA	VESA EDID structure 1.3
	Synchronization	VGA	Separate, Composite & SOG

Audio Connectivity	Audio Input	Connector	3.5mm stereo jack
		Impedance / Power level	30kΩ / 750mV
	Audio Output	Connector	3.5mm stereo jack
		Resistance / Power level	30kΩ / 2.8V
		Speaker Output	Power

*When the audio output is connected, speaker output is OFF

Power	Power Supply	Range	Auto-sensing 100 to 240VAC, 50 / 60Hz
		Power Consumption	Screen display ON
	Power saving mode		4W or less
	Power button OFF		1W or less

Regulatory	Safety Approval	FCC & CE
-------------------	-----------------	----------

Environmental Conditions	Operating	Temperature	0 to 50°C degree
		Humidity	20~90%, non-condensing
	Storage	Temperature	-5 to 60°C degree
		Humidity	5~90%, non-condensing
		Shock	10G acceleration (11ms duration)
		Vibration	5~500Hz 1G RMS random

Physical Specification		ID-E21Aw/ID-E21AwN	ID-E21Pw
	Product (W x D x H)	578 x 59 x 369 mm 22.7 x 2.3 x 14.5 inch	575 x 53 x 366 mm 22.6 x 2.1 x 14.4 inch
	Net Weight	5 kgs / 11 lbs	5 kgs / 11 lbs

Applicable Format	DVI-D / VGA Input	PC Signal	1920 x 1080 x 60Hz
			1280 x 1024 x 60 / 75Hz
			1280 x 960 x 60Hz
			1280 x 768 x 60 / 75Hz
			1152 x 864 x 75Hz
			1024 x 768 x 60 / 70 / 75Hz
			848 x 480 x 60Hz
			800 x 600 x 60 / 72 / 75Hz
			720 x 400 x 70Hz
			640 x 480 x 60 / 72 / 75Hz
			640 x 400 x 70Hz
	640 x 350 x 70Hz		
	HDMI Input	PC Signal	Same as VGA
			Video Signal
		Audio Signal	2ch Linear PCM (32 / 44.1 / 48 KHz)
Composite / S-Video Input			NTSC PAL

< 3.2 > OSD for Basic Inputs (VGA + DVI-D, for AD board 2.1)

- Power light
- Green = On
- Orange = Power saving

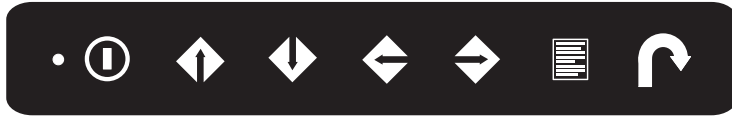

Membrane Switch

Function

	Power on / off LCD
	Display the OSD menu
	Scrolls through menu options and adjusts the displayed control (To auto adjustment by pressing the button for 5 seconds)
	Exit the OSD screen Toggle analog, digital & video connection (DVI-D and video options only)

Ver: G56SN20SSTD701 1024 x 768 59.8Hz

	Image
	Brightness <input type="range" value="50"/> 50
	Contrast <input type="range" value="50"/> 50
	Color Temp User
	Red <input type="range" value="255"/> 255
	Green <input type="range" value="255"/> 255
	Blue <input type="range" value="255"/> 255
Adjust: ←→ Select: ↑↓ Set: ●/■ Exit: ↵	

OSD Configuration Page



Image:

for the brightness, contrast, color temp, red, green, and blue

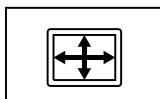

Geometry:

for the auto adjust, H position, V position, phase and clock



Video:

for the colour, tint, sharpness, noise reduction, DCDi and TV Setup



Audio:

for volume, bass, treble, balance, AVL and mute



Misc:

for the language, OSD position, graphic mode, ratio, reset and timer

< 3.2 > OSD for Upgrade Inputs

(VGA, DVI-D, HDMI, AV and Audio, for AD board 3.0)

① Picture

Picture mode :	Standard / Vivid / Soft / User mode to choose
Brightness :	Adjust background black level of the screen image
Contrast :	Adjust the difference between the image background (black level) and the foreground (white level)
Hue:	Adjust the screen hue value
Saturation :	Adjust the saturation of the image color
Picture size :	Adjust the image size
Color temp :	Standard / Cool / Warm / User to choose
Noise reduce :	Reduce the noise of the image
Sharpness :	Adjust the image from weak to sharp

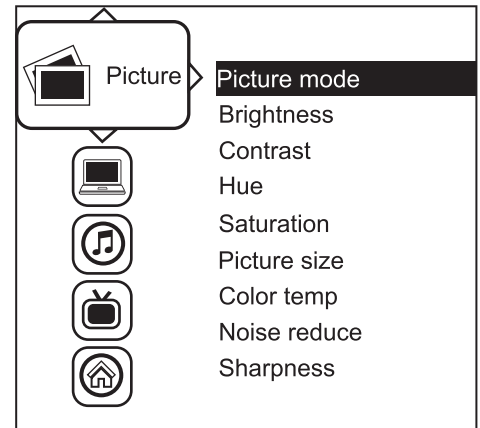

② PC

Auto adjust :	Automatically adjust sizes, centers and fine tunes the video signal to eliminate waviness and distortion.
Clock :	Adjust the clock value
Phase :	Adjust the phase value
H. Position :	Align the screen image left or right
V. Position :	Align the screen image up or down

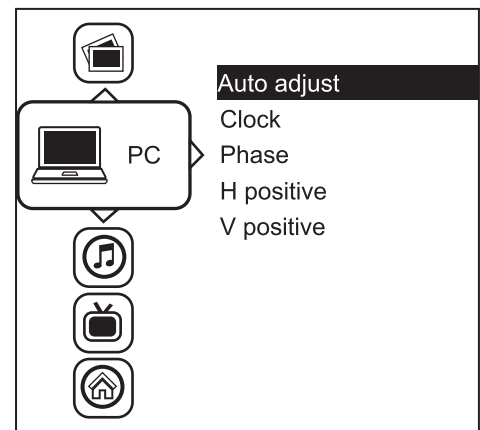

③ Audio

Audio mode :	Movie / Voice / Normal / Music mode to choose
Volume :	Adjust the volume of sound
Bass :	Set the value of bass sound
Treble :	Set the value of treble sound
Balance :	Set the balance value of treble and bass sound
Analog TV audio :	Set the value of analog TV audio sound
Mute :	Turn off the surrounding sound

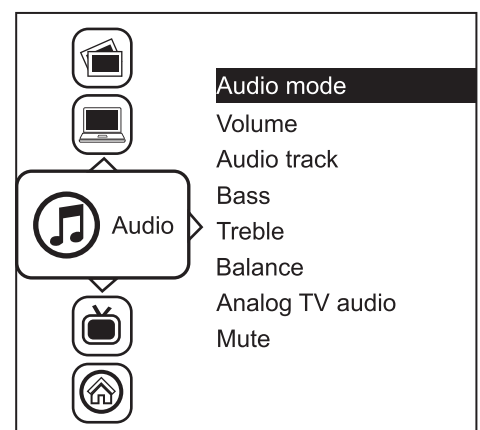

< 3.2 > OSD for Upgrade Inputs

(VGA, DVI-D, HDMI, AV and Audio, for AD board 3.0)

④ TV

Auto search :	Automatically search
Manual search :	Search the TV manual
Fine tune :	Fine tune the TV signal
Color system :	Adjust the TV color
Sound system :	Adjust the TV sound
Channel edit :	Edit the channel

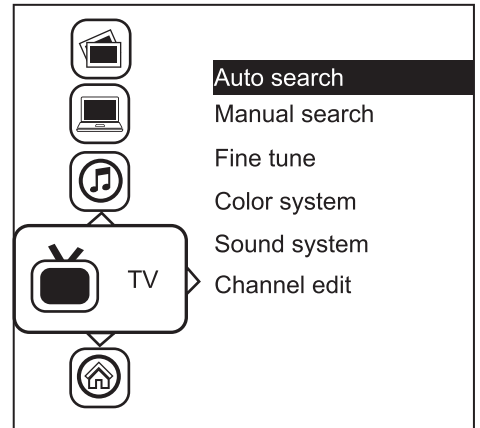

⑤ MISC

Language :	Select the language in which the OSD menu is displayed - English
Sleep timer :	Set the off time
PIP mode :	Adjust picture in picture setting
PIP position :	Enter into PIP position
PIP source :	Enter into the Sub source and sound source
System reset :	Return the adjustment back to factory setting
Information :	Select for Help

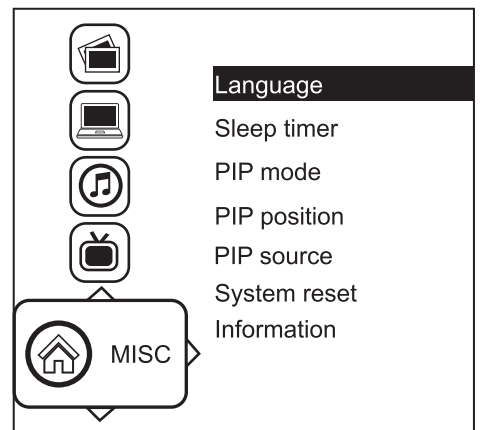

< Part 4 > Options

< 4.1 > Option Table

Basic Option	Aw / AwN	Pw
SDI ***	✓	✓
HDMI	✓	✓
S-Video + RCA	✓	✓
Audio	✓	✓
Touchscreen	✓	✓
MC multi-display control ***	✓	✓
DC Power	✓	✓
MIL-type / lockable connector	✓	✓
Quad display	✓	✓
TV *	✓	✓



(1) The user can only select either SDI or MC inputs.

(2) For SDI or MC input, the AD board will be upgraded to version 3.0, and this comes standard with HDMI, DVI-D, VGA, S-Video, RCA , audio inputs and remote controller.

*

For TV option , this comes with remote controller.

< 4.2 > Options : 3G / HD / SD-SDI input



Our SDI input is an ideal solution for the broadcast-grade video and high resolution CCTV market.

Designed for use with Full HD 1080p and ultra high resolution 1920 x 1200 LCD displays, we provide a SDI input module without using additional space or power.

SDI

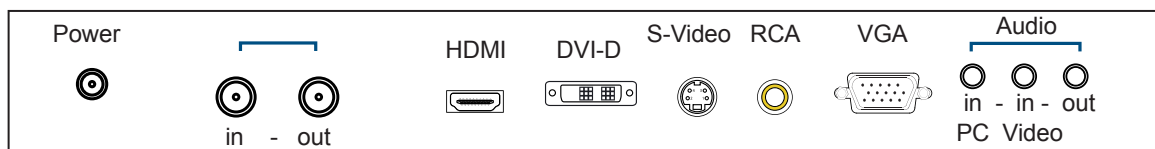

*** For **SDI** input, the AD board will be upgraded to version 3.0, and this comes standard with HDMI, DVI-D, VGA, S-Video, RCA , audio inputs and remote controller (please refer to P.24)

INPUT	3G-SDI IN	BNC x 1 / 0.8Vp-p (75 ohm)
	3G-SDI OUT	BNC x 1 / Active through, equalized & relocked

Standard Compliance	Video	SMPTE 425M / 274M / 296M / 125M ITU-R BT.656
	Audio	SMPTE 299M / 272M-C

Compatible Video Format	3G-SDI	1080p	@60 / 50Hz, 4:2:2
		1080p	@30 / 25 / 24Hz, 4:4:4
		1080i	@60 / 50Hz, 4:4:4
		720p	@60 / 50Hz, 4:4:4
	HD-SDI	1080p	@30 / 25 / 24Hz, 4:2:2
		1080i	@60 / 50Hz, 4:2:2
		720p	@60 / 50Hz, 4:2:2
	SD-SDI	480i	@60Hz, 4:2:2
ITU-R BT.656	576i	@50Hz, 4:2:2	

Compatible Audio Format	3G-SDI	48kHz, 16 / 20 / 24 bit, 2 CH, Synchronized Video
	HD-SDI	48kHz, 16 / 20 / 24 bit, 2 CH, Synchronized Video
	SD-SDI	48kHz, 16 / 20 / 24 bit, 2 CH, Synchronized / Asynchronized Video

Max. Transmission Distance 75 ohm coaxial cable	3G-SDI	150m at 2.97Gb/s
	HD-SDI	250m at 1.485Gb/s
	SD-SDI	480m at 270Mb/s

< 4.3 > Options : MC

MC (Multi-display Controller)



More control is always good. Especially when it is necessary and easy. Synergy Global Technology provides MC solution to control the OSD of various Industrial LCD displays up to 64 units.

The RS-232C is used for the communication between the PC and the first display via a 15 feet serial cable while the CAN bus is used for the various LCD displays cascade together via CAT 5/6 cable, and daisy chain up to 1,000 meters.

Designed for use with our Industrial LCD displays, we provide a MC input module without using additional space or power.

MC

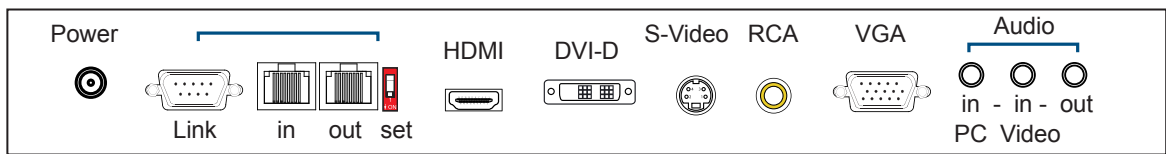

*** For **MC** input, the AD board will be upgraded to version 3.0, and this comes standard with HDMI, DVI-D, VGA, S-Video, RCA , audio inputs and remote controller (please refer to P.24)

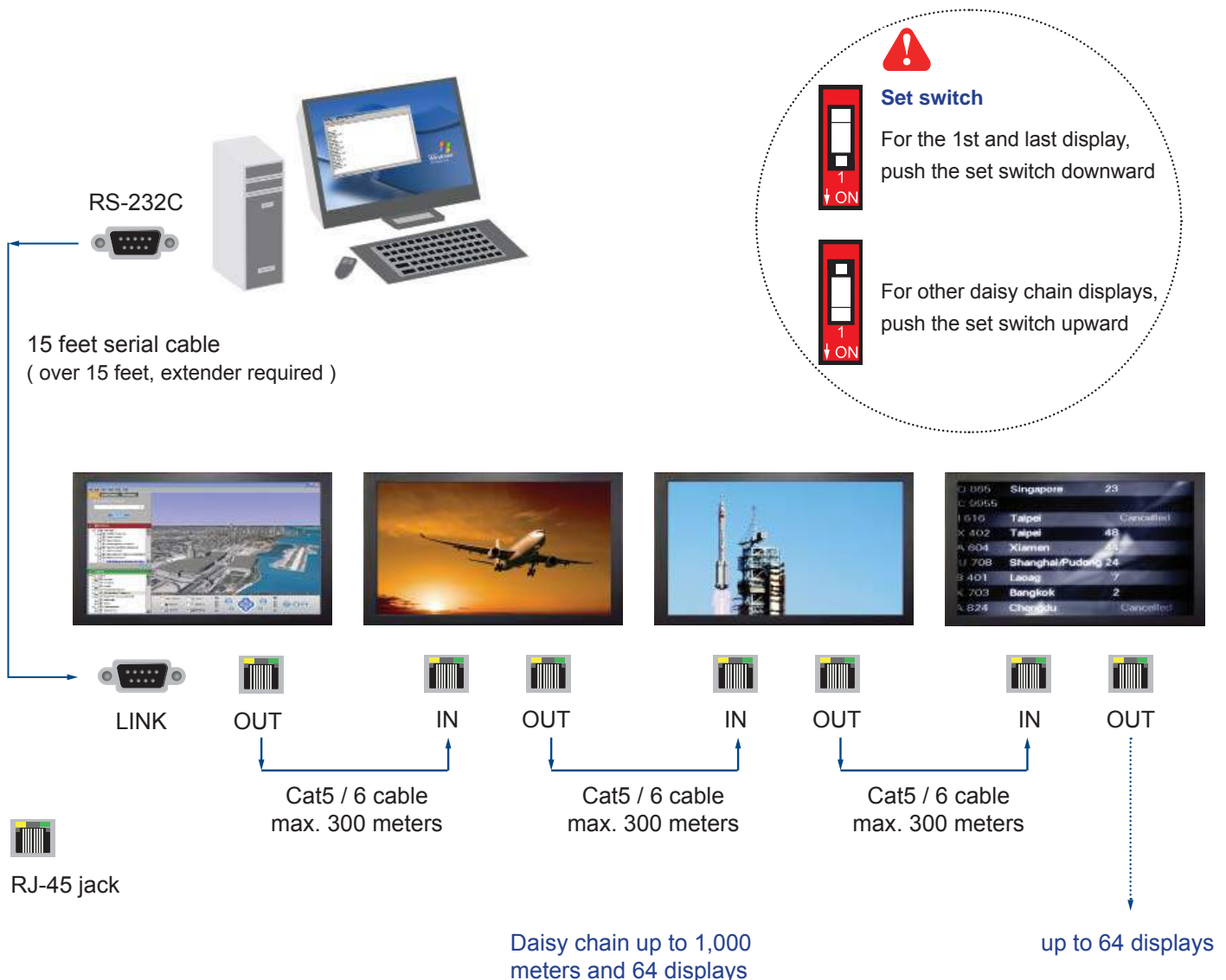

< 4.4 > Options : Touchscreen & driver

21" USB Touchscreen Specification

Model	TRB	TCB	TMC Multi-touch
Technology	5-Wire Resistive	Capacitive	Projected Capacitive
Touch Point	Single	Single	Dual
Method	Stylus or Finger	Finger	Finger
Activation Force	≤ 50g / Stylus=R0.8	≤ 50g	≤ 50g
Durability	10 million touches	300 million touches	100 million touches
Response Time	15 ms	20 ms	20 ms
Optical Transmittance	80% ± 3%	87% ±2%	90% ±2%
Surface Hardness	3H	9H	7H
Haze	8% ± 3%	7%	3%
Glass	3.2 ±0.2 mm	2.8 mm ±10%	2.4 ±0.15 mm
Connector	USB Type A		USB Type A
Compatibility	Windows 7 / XP / Vista, Linux		Windows 7

- USB touchscreen package includes 1 x 6ft USB cable, quick reference guideline and CD disc
- For detailed information, please refer to the attached CD disc
- As the touchscreen unit is not made of toughened glass, please handle it carefully

USB Touchscreen

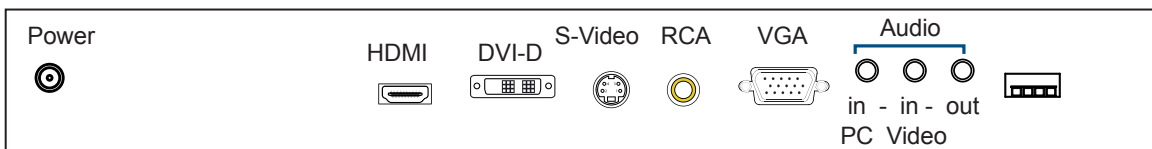

TRB & TCB Driver

Please follow the below steps to setup the touch screen:-

- Step 1.** Run the bundled CD disc or download the driver from the link below :
<http://www.rackmountmart.com/downloads.html>
- Step 2.** Double click the Setup.exe
- Step 3.** Follow the installation instruction to finish the setup
- Step 4.** After installation, run the TouchKit program & the “4 point calibration”



Please do the initial calibration after the first setup

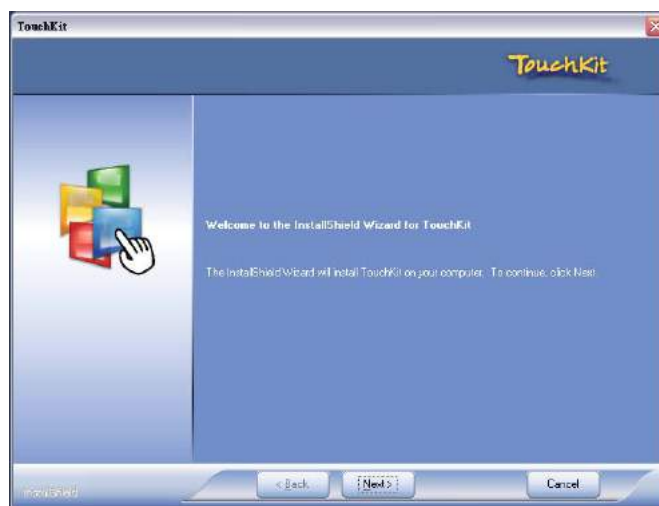

< 4.4 > Options : Touchscreen & driver



TMC Driver



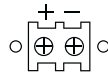

Connect the USB cable from the USB port on the LCD to a computer. The touch screen supports easy Plug-and-Play operations. There is no need to install additional drivers on the computer.

< 4.5 > Options : DC Power





Model	12V	24V	48V
Input rating			
Input voltage:	12-Volt	24-Volt	48-Volt
Input range:	9 ~ 18V	18 ~ 36V	36 ~ 75V
Input current			
- No load	50 mA	50 mA	50 mA
- Full load	4950 mA	2450 mA	1220 mA
Output rating			
Output voltage:	12-Volt	12-Volt	12-Volt
Output current:	4.16A	4.16A	4.16A
Efficiency	84%	85%	85%

< 4.6 > Options : MIL-type or Lockable Connector

	Input	Part no.	MIL Standard
MIL - type Connector	DC Power *** (Male)	-MD (MS3470W8-33P) 	MIL - DTL - 26482
	VGA *** (Male)	-MA (MS3470W14-15P) 	MIL - DTL - 26482

*** There are several additional MIL DC and VGA connector types with varying design characteristics to meet cost considerations and to provide users with the most design flexibility possible. For more information, please contact us.

	Input	Part no.	Standard
Lockable Connector	DC Power (Male)	-LD 	D-type 3W3
	USB	-LS 	

*** MIL - type or Lockable connectors above can be integrated with our LCD displays. Sale service just for connectors not provided.

< 4.7 > Options : Quad Display

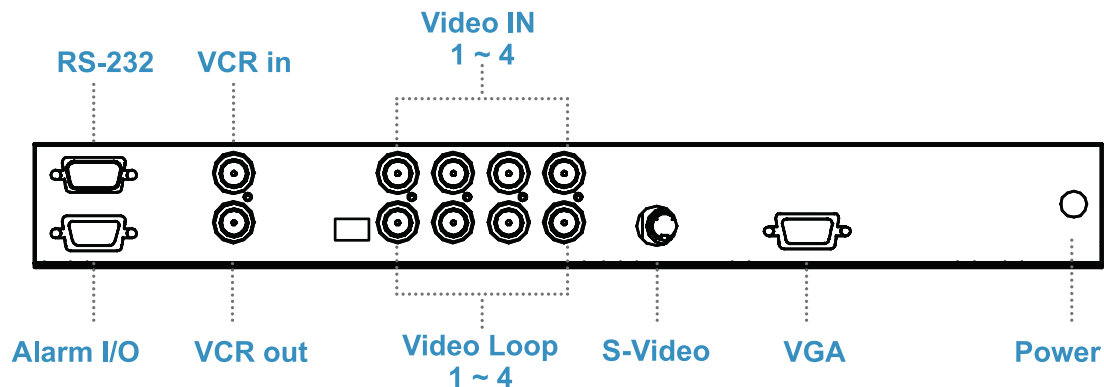

QD Specification

Item		Description	
Model Number		QD (NTSC)	QD (PAL)
Number of Color		16.7 M	16.7 M
Imaging System		NTSC	PAL
Resolution		1024 x 525	1024 x 625
Refresh Rate		60	50
Video Input	Camera Input	1.0 Vpp, 75 Ohm x 4	
	VCR Input	1.0 Vpp, 75 Ohm x 1	
Video Output	Live Monitor	1.0 Vpp, 75 Ohm x 1	
	Loop Through Out	1.0 Vpp, 75 Ohm x 4	
	VCR Output	1.0 Vpp, 75 Ohm x 1	
Auto Gain Control		Yes	
Time / Date		Yes	
On Screen Display		Yes	
Camera Title		8 Character Title	
Display Format	2 x Zoom On Playback	Yes	
	QUAD	Yes	
	FULL	Yes	
	SEQUENCY	Yes	
Dwell Time		0 to 99 Sec Adjustable	
Alarm Inputs		Selectable NO/NC Contacts x 4	
Relay Outputs		NO/NC contacts x 1: 1A @DC24V Max.	
Alarm Hold Time		1 Sec to Non-stop	
Built-in Buzzer		Yes	
Key Lock		Yes	

*** For QD option, the casing dimensions will be changed.

< 4.8 > Options : TV (Analog)

TV

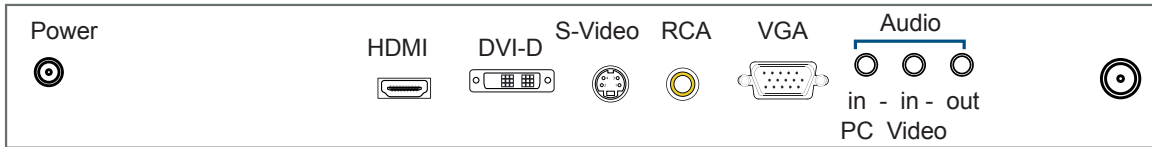

- (1) For TV option, the AD board will be upgraded to version 3.0, and this comes standard with HDMI, DVI-D, VGA, S-Video, RCA , audio inputs and remote controller.
- (2) For TV option, casing dimensions will be changed.

How to Use RC-2 Remote Controller

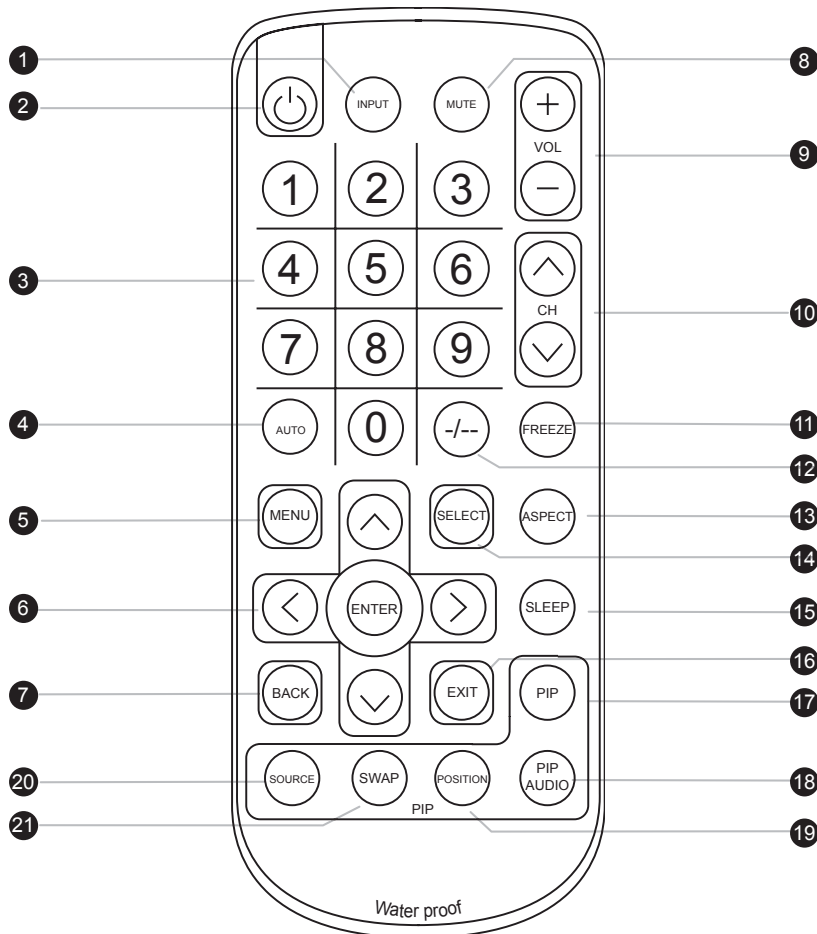

①	INPUT	Select the source
②		Switches on or off the TV
③	0 - 9	Only use in TV mode. Select channels. For channel numbers 10 and above, enter the second digit within two seconds.
④	AUTO	Auto adjust
⑤	MENU	Display the menu on the screen or go to the previous menu
⑥	▲ / ▼ / ◀ / ▶ / ENTER	Go to the upper menu or select the previous value / Go to the next menu or select the next value / Decrease the setting value / Increase the setting value or enter to the select item setting Enter to the select item settings or excude the setting
⑦	BACK	Back to previous value
⑧	MUTE	Turn on or off the speaker
⑨	Vol + / -	Increase or decrease the speaker volume
⑩	CH + / -	For TV model only, increase or decrease the channel number
⑪	FREEZE	Reserve for OEM model
⑫	- / --	For setting input single or double digits
⑬	ASPECT	Adjust the screen size
⑭	SELECT	To select the existing item
⑮	SLEEP	Select the sleeping time
⑯	EXIT	Exit the menu or cancel
PIP functions		
⑰	PIP	Picture in picture
⑱	PIP AUDIO	To set the audio of in PIP mode
⑲	POSITION	To set the screen position in PIP mode
⑳	SOURCE	PIP Source
㉑	SWAP	Swap screen in PIP mode

The company reserves the right to modify product specifications without prior notice and assumes no responsibility for any error which may appear in this publication.

All brand names, logo and registered trademarks are properties of their respective owners.

Copyright 2012 Synergy Global Technology Inc. All rights reserved.