

DETAILS

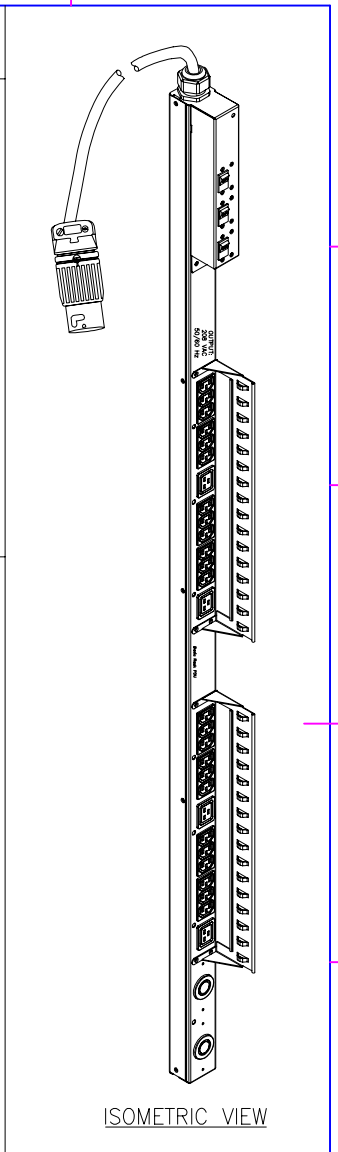
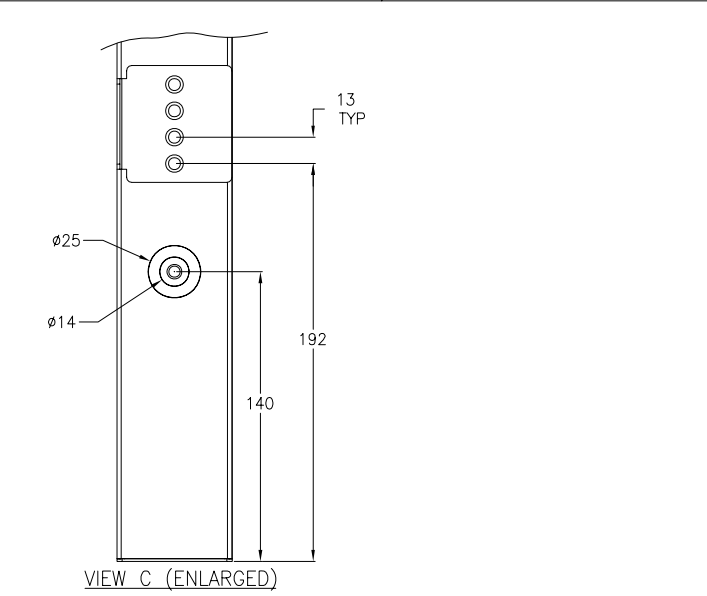
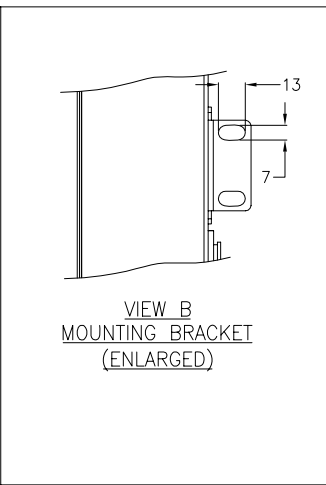
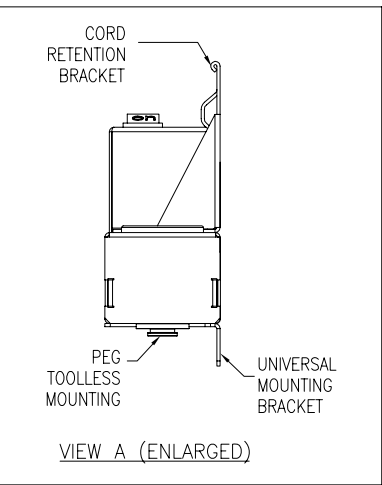

- NOTES:
1. ALL DIMENSIONS ARE IN MILLIMETERS.
 2. NET WEIGHT IS 7.32 kg.
 3. LENGTH OF THE CORD IS 914 mm.
 4. UNIVERSAL MOUNTING BRACKET IS AN ALTERNATIVE MOUNTING METHOD TO THE TOOLLESS MOUNT FOR NON APC RACKS.
 5. BRACKET KITS TO MOUNT TO SPECIFIC COMPETITORS RACKS ARE AVAILABLE AS OPTIONS.
 6. INSTALLATION MUST COMPLY WITH ALL APPLICABLE NATIONAL AND LOCAL CODES.